



Vapor Recovery Monitoring

Installation, Operation, and Maintenance Manual
For use with Healy Vapor Recovery System
Software Version 1.2.0

Franklin Fueling Systems • 3760 Marsh Rd. • Madison, WI 53718 USA
Tel: +1 608 838 8786 • 800 225 9787 • Fax: +1 608 838 6433 • www.franklinfueling.com

Notice

Franklin Fueling Systems (FFS) reserves the right to change this document and specifications at any time without notice. FFS makes no expressed or implied warranty with regard to the contents of this manual. FFS assumes no liability for errors or omissions, or for any damages, direct or consequential, that may result from the use of this document or the equipment that it describes. No part of this document may be reproduced in any form without the prior written consent of FFS.

Trademarks

INCON, Fuel Management System, System Sentinel, SCALD, Brite, BriteBox, BriteBus, and BriteSensors are registered trademarks of Intelligent Controls. All brand and product names are trademarks or registered trademarks of their respective companies.

Inspection of Materials

Visually inspect all components for defects or damage prior to installation. If any defects or damage is found, do not use the product and contact FFS for further assistance.

Return Shipping Charges

FFS will not accept shipments of returned products without a Return Goods Authorization (RGA) number. RGAs are obtained by contacting FFS's Technical Service Division — NO RGAs will be given without the unit's serial number(s). Returned goods remain the property of the buyer until replaced or repaired.

Contacting Franklin Fueling Systems (FFS)

Please feel free to contact us by mail at:

Franklin Fueling Systems
3760 Marsh Rd.
Madison, WI 53718 USA

Or contact us by phone, fax, or email:

Tel: 1 608 838 8786

Fax: 1 608 838 6433

Tel: US & Canada 1 800 225 9787

Tel: México 001 800 738 7610

Tel: Europa +49 6571 105 380

E-mail: sales@franklinfueling.com

techserve@franklinfueling.com

Office Hours: 8am to 5pm CST - Monday through Friday

Please visit our Web site at www.franklinfueling.com

Contents

Notice	2
Trademarks	2
Inspection of Materials.....	2
Return Shipping Charges.....	2
Contacting Franklin Fueling Systems (FFS)	2
Important Safety Messages	4
Introduction	5
Certified Contractor Requirements	5
Definitions and Acronyms	5
Related Documents	5
Product Description	6
Vapor Recovery Monitoring.....	6
VRM System Specification	8
Installation & Startup	9
TS-550/5000/EMS Console Installation.....	9
TS-VFM Installation	9
TS-VPS Installation.....	9
Dispenser Hook Signals.....	10
Dispenser Power Control	10
Dispenser Interface Module.....	11
Ullage Volume Input.....	11
Setup and Programming	12
Startup	12
System Status.....	12
Programming the Console for Vapor Recovery Monitoring.....	13
Data Transfer Units	13
Dispenser Hooks Mapping.....	13
Vapor Flow Meter Select.....	13
Vapor Pressure Sensor Select.....	13
Remote ATG Serial Port Settings.....	13
Relay Mapping	14
Dispenser Interface	14
Vapor Recovery Monitoring Setup	15
Managing Rules.....	16
Setting Up Email Notification	17
System Operation	18
Run-Time Status	18
Vapor Recovery Web Pages.....	18
Alarms, Warnings, and Failures	22
System Alarms	22
Vapor Recovery Alarms	22
Reports & Printing	25
Creating Reports	25
Printing Reports	26
Printing VRM Report examples	27
Maintenance	28
General Inspection.....	28
Diagnostics	29
Pressure and Transaction Log Files	29
Pressure Log Files.....	29
Transaction Log files.....	30
Steps to Download Log Files	31
INCON VRM Startup Checklist	32
Appendix A: Alarm Codes	33

Important Safety Messages

INCON equipment is designed to be installed in association with volatile hydrocarbon liquids such as gasoline and diesel fuel. Installing or working on this equipment means working in an environment in which these highly flammable liquids may be present. Working in such a hazardous environment presents a risk of severe injury or death if these instructions and standard industry practices are not followed. Read and follow all instructions thoroughly before installing or working on this, or any other related, equipment.

As you read this guide, please be aware of the following symbols and their meanings:

Warning  This symbol identifies a warning. A warning sign will appear in the text of this document when a potentially hazardous situation may arise if the instructions that follow are not adhered to closely. A potentially hazardous situation may involve the possibility of severe bodily harm or even death.

Caution  This is a caution symbol. A caution sign will appear in the text of this document when a potentially hazardous environmental situation may arise if the instructions that follow are not adhered to closely. A potentially hazardous environmental situation may involve the leakage of fuel from equipment that could severely harm the environment.

Danger  This symbol identifies an electrical danger. An electrical danger sign will appear in the text of this document when a potentially hazardous situation involving large amounts of electricity may arise if the instructions that follow are not adhered to closely. A potentially hazardous situation may involve the possibility of electrocution, severe bodily harm, or even death.

Warning  **Follow all applicable codes governing the installation and servicing of this product and the entire system. Always lock out and tag electrical circuit breakers while installing or servicing this equipment and any related equipment. A potentially lethal electrical shock hazard and the possibility of an explosion or fire from a spark can result if the electrical circuit breakers are accidentally turned on during installation or servicing. Please refer to the *Installation and Owner's Manual* for this equipment, and the appropriate documentation for any other related equipment, for complete installation and safety information.**

Warning  **Follow all federal, state and local laws governing the installation of this product and its associated systems. When no other regulations apply, follow NFPA codes 30, 30A and 70 from the National Fire Protection Association. Failure to follow these codes could result in severe injury, death, serious property damage and/or environmental contamination.**

Warning  **Always secure the work area from moving vehicles. The equipment in this manual is usually mounted underground, so reduced visibility puts service personnel working on this equipment in danger from moving vehicles entering the work area. To help eliminate these unsafe conditions, secure the area by using a service truck to block access to the work environment, or by using any other reasonable means available to ensure the safety of service personnel.**

Warning  **When the console system is used to monitor tanks containing gasoline or other flammable substances, you may create an explosion hazard if you do not follow the requirements in this manual carefully.**

Warning  **All wiring must enter the console's enclosure through the designated knockouts. An explosion hazard may result if other openings are used.**

Warning  **All wiring from probes or sensors to the console must be run in conduit separate from all other wiring. Failure to do so will create an explosion hazard.**

Warning  **Substituting components could impair intrinsic safety. T5 series consoles are intrinsically safe for sensors installed in – Class I, Division 1, Group D – hazardous locations. Substitution of components could make the energy limiting circuitry in the system ineffective and could cause an explosion hazard. Repairs to a T5 series console or attached components should only be performed by a qualified, factory-trained technician.**

Introduction

The purpose of this manual is to guide installers, operators, and store owners with setting up their INCON Vapor Recovery Monitoring (VRM) system. The VRM system has been tested and approved by the California Air Resource Board as an In-Station Diagnostics (ISD) system per CP-201. This manual introduces the user interface then proceeds to setup and lastly, maintaining your VRM system.

For installation of the TS-550, TS-5000, TS-EMS and its components please refer to the *TS-5xxx Series Installation Guide* (p/n 000-2150).

Certified Contractor Requirements

Please read this entire manual carefully. Failure to follow the instructions in this manual may result in faulty operation, equipment damage, injury or death.

Contractor Certification Levels

- LEVEL I - Automatic Tank Gauge Installer Certification Training
- LEVEL II - Automatic Tank Monitor Start-Up and Service/Warranty Certification Training
- LEVEL III - LLD Installer/Service/Warranty Certification Training
- LEVEL IV - TS-STC Operation/Repair Test
- LEVEL V - Vapor Recovery Monitoring Installation/Operation

Certified Programmer/Service Person: Only an INCON certified VRM Technician or service person is allowed to make setup changes, clear alarms, and access areas internal to the Console. A certified contractor needs to have completed training levels I, II, and V.

Station Owner/Operator: The station owner or operator of the console is only allowed to print reports and re-enable dispensers. Making setup changes, clearing alarms, and accessing areas internal to the console is strictly prohibited.

Definitions and Acronyms

A/L – Air over Liquid ratio, this ratio is calculated at the end of the day for each fueling point.

ATG – Automatic Tank Gauge

CARB – California Air Resources Board

DTU - Data Transfer Unit. Device used to transmit VFM and VPS data over existing power lines

EVR – Enhanced Vapor Recovery

GDF – Gasoline Dispensing Facility

ISD – In-Station Diagnostics. This refers to the whole system as defined in CP-201.

ISP – Internet Service Provider

LLD – Line Leak Detector

Modules – These are the different plug-in cards within the T5 series console enclosure. They are the inputs and outputs for all the field wiring.

Console – The console is the physical box installed on the wall. The system console holds the entire electronic slide in modules and runs the general operating system. The VRM application is available in the TS-550/EMS/5000 models of the console.

PLC - Power Line Communication. This refers to the technology of transferring digital data over AC power lines

TS-VFM – Vapor Flow Meter

TS-VPS – Vapor Pressure Sensor

TSA – Tank Sentinel Anyware is the web-based interface to the console.

VRM – Vapor Recovery Monitoring is the application that runs on the console and performs In-Station Diagnostics.

Related Documents

000-2144, *TS-VFM Installation Guide*

000-2143, *TS-VPS Installation Guide*

000-2150, *TS-5xxx Installation Guide for TS-5, TS-550, TS-5000, and TS-EMS*

000-2142, *TS-5xxx Programmer's Guide for TS-5, TS-550, TS-500, and TS-EMS*

000-2151, *TS-5xxx Operator's Guide*

CP-201, *Certification Procedure for Vapor Recovery Systems at Gasoline Dispensing Facilities*

TP-201.3, *Determination of a 2" Static Pressure Performance of Vapor Recovery Systems of Dispensing Facilities*

TP-201.5, *Air to Liquid Volume Ratio*

Product Description

Vapor Recovery Monitoring

The Vapor Recovery Monitoring System (VRM) consists of the following components.

Vapor Recovery Monitoring Application

The Vapor Recovery application uses data from the Vapor Flow Meters (VFMs) and the Vapor Pressure Sensor (VPS) to perform assessments on the site's vapor recovery system. VRM is an optional application on the console and may be accompanied by Fuel Management System or Secondary Containment Monitoring.

Console

The Console consist of either the TS-550 or TS-5000 Fuel Management Systems or the TS-EMS, Environmental Monitoring System. The console options for ISD monitoring will always include the VRM application and at least one of each of the following components. (See Figure 1)

- AC Input Module
- Relay/10A Relay Module
- Probe Module
- 4-20mA Module
- Dispenser Interface Module
- Printer
- Touchscreen



Vapor Flow Meter

The Vapor Flow Meter (TS-VFM) is a volume measuring meter. When a mixture of air and gasoline vapors are returned from an automobile's gasoline tank to the underground storage tank during a dispense, the vapors are measured and analyzed. The console uses these VFMs as a way to assess how well the vapor collection process is working. The VFM is used to perform the following CP-201 assessments.

Assessment Type	Duration	EVR System	Threshold
Daily A/L	Daily	Vacuum Assist	Average A/L ratio exceeds 1.90 or less than 0.33
Weekly A/L	Calendar Week	Vacuum Assist	Average A/L ratio exceeds 1.32 or less than 0.81

There shall be one VFM per dispenser, and they wire into the Probe Module. Refer to document *Vapor Flow Meter Install Guide* (p/n 000-2144) for installation methods.

Vapor Pressure Sensor

The Vapor Pressure Sensor (TS-VPS) is a low vapor pressure transmitter. The primary purpose of the VPS is to continually measure the underground storage tank's vapor containment pressure. This vapor containment area includes the tank ullage area, and the vapor piping. The VRM continually samples the VPS and performs assessments for Over Pressurization and leakage in the vapor containment area. These assessments include:

Assessment Type	Duration	Threshold
Weekly Over-pressurization	Calendar Week	Pressure > 1.3" wcg for 5% of week
Monthly Over-Pressurization	Calendar Month	Pressure > 0.3" wcg for 25% of month
Weekly Leak Test	Calendar Week	Pressure Leak is greater than 2x TP-201.3

There is only one VPS per ISD installation. The VPS connects to the 4-20mA Module, refer to the *Vapor Pressure Sensor Install Guide* (p/n 000-2143). The pressure sensor shall be installed in the dispenser closest to the underground storage tanks.

AC Input Module

In VRM Version 1.2.0, the use of dispenser AC Hook signals is not required. The AC Input Module may be used to monitor the dispenser hook signals. Dispenser hooks are the signals from the dispensers that are normally used to activate the submersible pumps. For the VRM application they are also used to signal the start and end of a transaction for gasoline products only. Vapor Recovery does not apply to Diesel and Kerosene products so the hook signals for these grades do not need to be monitored. Dispenser Hook Signals are to be wired to the AC-Input Module and the installation directions are in the *TS-5xxx Installation Guide* (p/n 000-2150).

Dispenser Interface Module

The Dispenser Interface Module (TS-DIM) is used to acquire the volume of gasoline that was pumped during each transaction. Refer to the *TS-5xxx Installation Guide* (p/n 000-2150) for wiring the TS-DIM.

Ullage Volume

The VRM System uses ullage volume for performing vapor containment leak detection. The console gathers ullage volume from internal inventory probes or an external ATG. When using an existing ATG for collecting ullage, then the ATG must have an available RS-232 port and have the ability to respond to TLS-250 or TLS-350 inventory command.

Relay/10A Relay Module

Power to the dispensers will be controlled by the console in the event of a VRM Failure alarm. The dispenser power is to be controlled by the Relay Module per the installation directions in the *TS-5xxx Installation Guide* (p/n 000-2150). Electrical current through the Relay Module is not to exceed the maximum rated current listed on the module. If options in the dispensers will cause the current to exceed the rated current, including startup current, an external power relay will need to be used and it's coil controlled by the Relay Model. See the *TS-5xxx Installation Guide* (p/n 000-2150) for installation instructions for the Relay Module and 10A Relay Module.

DTU Module

The DTU Module is an optional device used to transmit the signals of the VPS and VFM to the console. The DTU will provide the ability to communicate over existing dispenser power lines thus eliminating the need to install field cable. For installation instructions of the DTU, refer to the TS-DTU Dispenser Retrofit Manual (pn 000-2146) and the Console DTU Installation Instructions (pn 000-0080).

Alarms

The user will be automatically notified of VRM or other system alarm conditions via the alarm LEDs and touchscreen display. An audible alarm will sound and the system can also be setup to print or E-mail alarms (Ethernet connection required). Dispenser power is controlled by the console and cannot be disabled.

VRM System Specification

Refer to the Executive Order 202, Exhibit 2, for the most up to date system specifications. The required equipment to be installed for the INCON VRM system is discussed below. Figure 1 shows the different components and where they attach to the Console. All items in bold are items directly related to the VRM application.

Figure 1

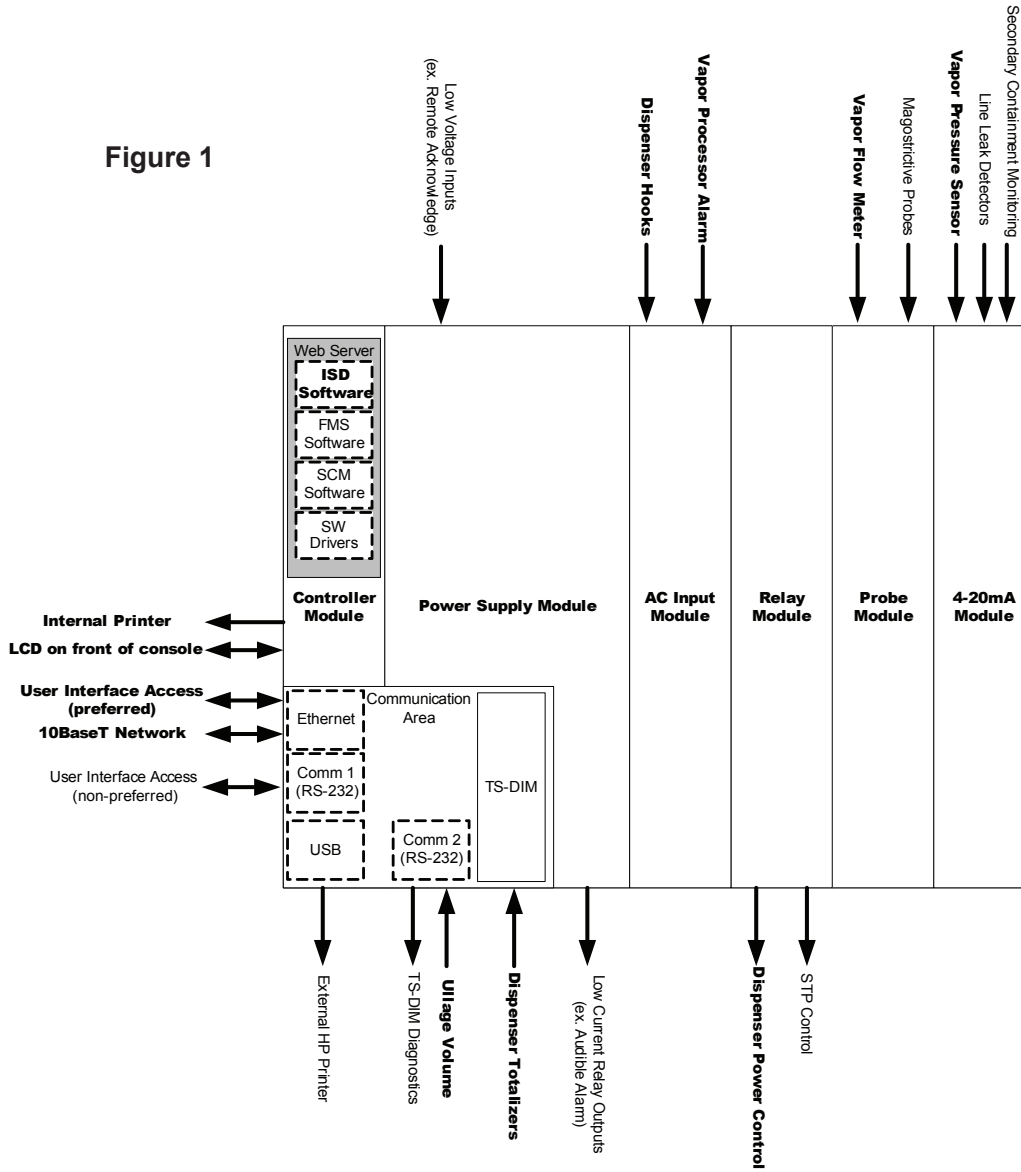

Installation & Startup

TS-550/5000/EMS Console Installation

The console will be shipped with all modules installed and tested. Refer to the *TS-5xxx Installation Guide* (p/n 000-2150) for mounting and wiring instructions.

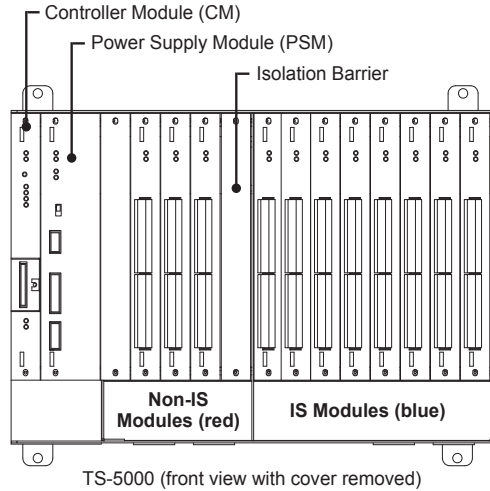

TS-VFM Installation

Field Installation

To mount the Vapor Flow Meter (VFM) in the dispenser and make the field wiring connections, follow the instructions in the *TS-VFM Install Guide* (p/n 000-2144).

Console Wiring Connection

See Probe Module diagram at right. The VFM is wired to the Probe Module inside the Console. Wire the Red wire to the + terminal and the Black wire to the – terminal.

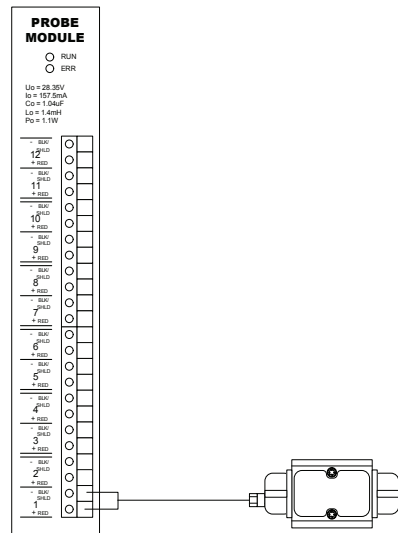

TS-VPS Installation

Field Installation

To mount the Vapor Pressure Sensor (VPS) and make the field wiring connections, follow the instructions in the *TS-VPS Install Guide* (p/n 000-2143). There will be only one pressure sensor per ISD System.

Console Wiring

See diagram at right. The VPS is wired to the 4-20ma Module inside the Console. Wire the sensor's Black wire to the + terminal and the sensor's White wire to the - terminal.

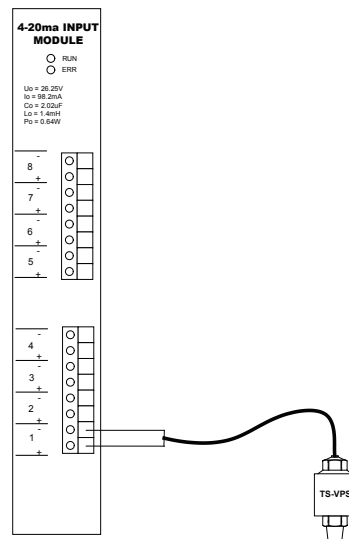

There are several different wiring schemes that may be encountered when connecting the AC Input Module and Relay Module. These are dependent upon the use of optional features like Dispenser Hook Isolation, Line Leak Detection (LLD) and Turbine Pump Interface that can affect the way these modules are wired. The description below assumes that this is strictly a VRM system that is sensing the dispenser hook signals from gasoline products only and not controlling the Submersible Turbine Pumps. For more information on the different wiring options see the *TS-5xxx Installation Guide* (p/n 000-2150) or contact Franklin Fueling Systems Technical Support at 1-800-984-6266.

Dispenser Hook Signals

Note: Dispenser hook signals are required on installations prior to VRM versions 1.2.0.

The dispenser hook signals are sampled by the AC Input Module so that the VRM can monitor the start and end of gasoline sales transactions. Follow the instructions below to tap into the Dispenser Hook Signals with a parallel wire to the AC Input Module. This method will not take control of the Submersible Pumps.

1. Locate the gasoline product only dispenser hook signals at a point where they are still separated by dispenser. This may be a dispenser hook isolation box or other method or they may just all be connected with a wire nut.
2. Separate them by dispenser number then by fueling grade.
3. Connect a wire in parallel from the line and neutral of each dispenser hook signal to the AC Input Module. All existing wiring should remain as is.
4. When wiring the Dispenser Hook signals to the AC Input Module, make dispenser 1 signals (all gasoline grades) go to the first set of terminals. For example, if there are two hooks per dispenser (Regular and Super) then wire Dispenser 1 to positions 1 & 2, then Dispenser 2 to positions 3 & 4.

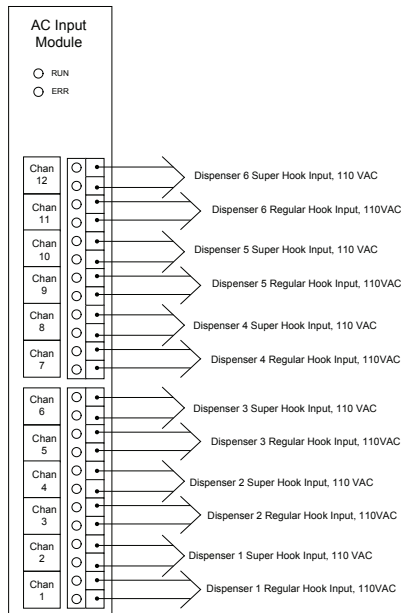

Dispenser Power Control

In order for the console to shutdown a dispenser or all the dispensers in response to an alarm condition, the dispenser power must be controlled by the Relay Module. Run the coil of the dispenser power relay through the a channel of the Relay Module.

The 10A Relay Module is rated for 10 amps of continuous current. If the dispenser power, including startup current, exceeds 10A then an external high powered relay must be installed to control the dispensers. It is a good practice to wire the dispenser power in a logical order such as Dispenser 1 to Relay Channel 1, Dispenser 2 to Relay Channel 2, etc.

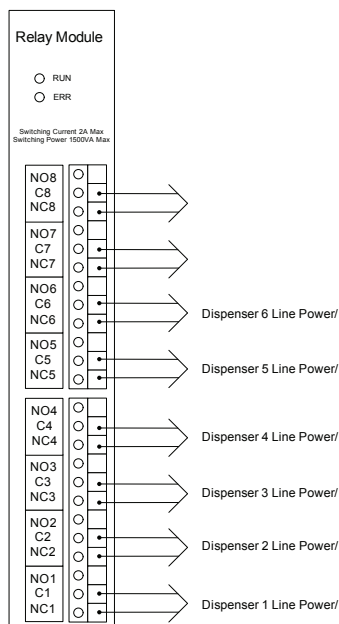

Dispenser Interface Module

The Dispenser Interface Module (DIM) is a device attached to the Power Supply Module. Connections to the DIM are located on the bottom left side of the Console using the appropriate cable kit based on the dispenser type.

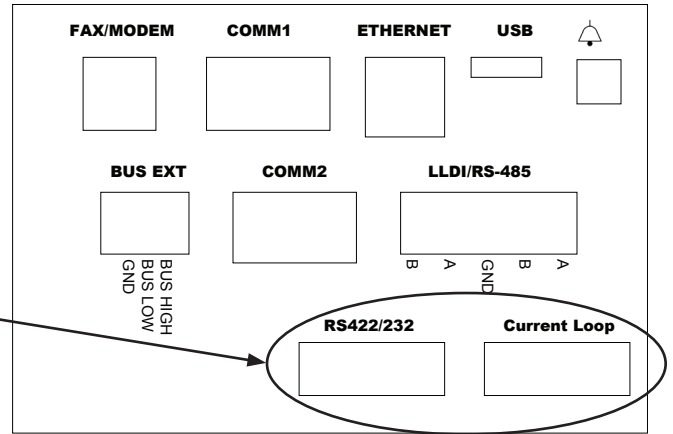

Ullage Volume Input

The console can gather ullage volume from either the internal inventory probes or from existing inventory probes through an External ATG.

Using Internal Magnetostrictive Probes

To use internal magnetostrictive probes, you must have Fuel Management System (FMS) enabled in the registration. See the *TS-5xxx Programming Manual* for instructions for programming the FMS section. The FMS section must be programmed before the VRM section.

Using an External ATG

There are certain requirements in order to retrieve ullage volume from an external ATG.

- Continuous access to a RS-232 connection
- Ability to respond to the following serial Command:
 - Command: **i201TT** - *In-Tank Inventory Report, TLS-350 command set*
 - Command: **10T** - *Inventory Report, TLS-250 command set*
- Serial Cable with the following specifications:
 - Cable must be a 'Null' Serial
 - DB9 Male (INCON Console) to either DB25 Male or DB9 Male (ATG)

Use the following steps to connect an External ATG to a Console:

1. Connect the DB9 female end of the cable to Comm 2 on the Console.
2. Connect the other end of the cable to the serial port of the External ATG.
3. Set the serial port parameters to match between the Console and the External ATG, see *TS-5xxx Setup Programming Guide*.
4. Validate there is no "External ATG Communication" alarm.

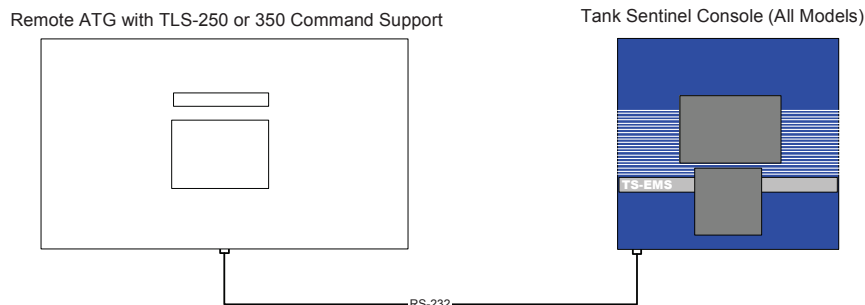

Note: A DB25 to DB9 Null Serial Cable may be purchased from INCON, PN 600-0099. See the *TS-5xxx Series Installation Manual* "Communication Ports" section for pinouts of Comm Port 2.

Setup and Programming

Startup

Upon completing the installation of the Vapor Recovery Monitoring (VRM) System and powering up the Console, programming the setup is the next step.

System Status

The Console will arrive at the site with the VRM application already enabled. Upon first powering up the console you may see a screen that looks like the one in Figure 2a. The system with the screen in Figure 2a has the VRM application as well as the Fuel Management System (FMS) application enabled. These applications are set by a registration key at the time of purchase.

The first step before programming the VRM is to check to see if all the modules are powered up and operational. Select the **System** box which brings up the **System Status** page as shown in Figure 2b.

Figure 2a and 2b

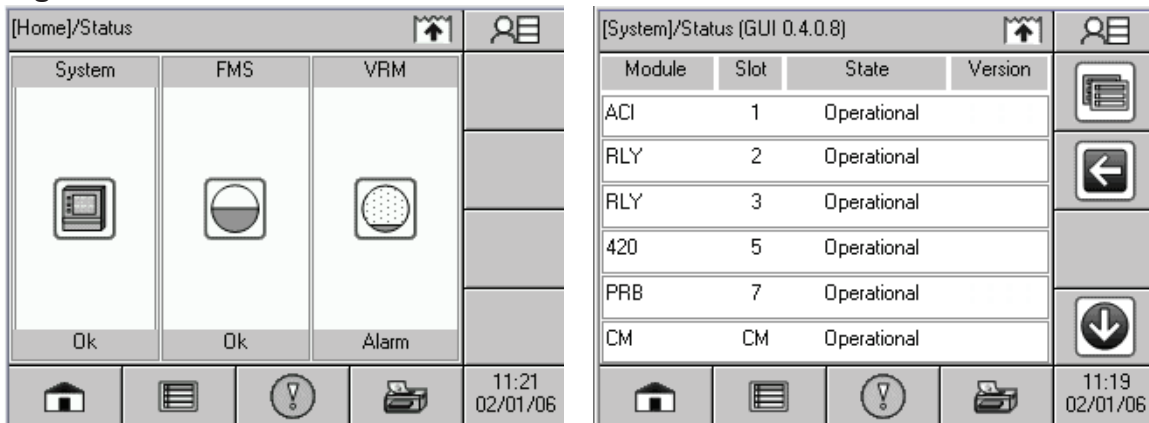

Verify all the modules are present and operational. If all the modules are “Operational” then you may proceed to setup and programming. If not, refer to the Alarm Codes and Troubleshooting section of this manual.

Programming the Console for Vapor Recovery Monitoring

The following programming instructions are specifically intended for the Vapor Recovery Monitoring (VRM) System. For additional programming refer to the *TS-5xxx Programming Manual* (p/n 000-2142). This manual covers both the hardware programming and the application programming. The method shown below is the same whether the user programs through the local touchscreen or a Web Browser. Inclusion of other options like the FMS application, Dispenser Hook Isolation and Line Leak Detection (LLD) will effect the programming of the VRM system. The *TS-5xxx Programming Manual* (p/n 000-2142) describes the proper programming and sequencing for the console setup. The following sections show how to program the setup as it relates to the VRM system. Contact Franklin Fueling Technical Support at 800-984-6266 for assistance with these applications.

Data Transfer Units

This is an optional hardware interface to communicate the VPS and VFM and Dispenser Shutdown over existing dispenser AC power line. If a TS-DTU was installed then the following setup is required.

Group Name	Parameter Name	Parameter Value	Explanation	
Remote Data Transfer Units	Network ID	1	Leave as default. In rare circumstances the network ID may need to change if another network is near.	
Dispenser Configuration	Number of Units	1	Enter the number of DTU Modules at the dispensers. This does not include the console DTU.	
	TS-DTU 1	Unit ID	14-EEA8-FFFF-0000-1A	This is the unique ID located on the DTU label. The console uses this ID to know which modules to communicate with.

Dispenser Hooks Mapping

Mapping the gasoline dispenser hooks signals correctly is important for the VRM to properly identify active fueling points. The dispenser hooks must be wired correctly as explained in the *TS-5xxx Installation Guide* (p/n 000-2150).

Note: Dispenser Hook Signals are only required on installations prior to VRM Version 1.2.0.

Group Name	Parameter Name	Parameter Value	Explanation	
AC Input Modules	Number Gasoline Hooks per dispenser	0	Set to zero if not using dispenser hook signals, otherwise the number of gasoline hooks coming from each dispenser	
Module #	Channels	(n)	Select number of gasoline dispenser hook signals available from each dispenser. The Vapor Recovery Monitor does not use any non-gasoline products.	
	Channel #	Name	Ex. Dispenser 1 Hook Regular	Unique name for the hook signal
		Enabled	Yes	Select "Yes"
		Active High	Yes	Set to "Yes"

Vapor Flow Meter Select

The Vapor Flow Meter (VFM) select is located under the Probe Module. This is where we define the number of input channels and select the VFM. Go to the Probe Module setup and make the following changes. If the FMS application is also running, some of the channels will be designated for probes.

Group Name	Parameter Name	Parameter Value	Explanation	
Probe Modules				
Module #	Channels	(n)	Select the number of flow meters/probes at the site	
	Channel #	Name	Ex. VFM Disp 1	Unique name for Vapor Flow Meter
		Enabled	Yes or No	Set to "Yes"
		Type	TS-VFM	Select Vapor Flow Meter type

Vapor Pressure Sensor Select

The Vapor Pressure Sensor (VPS) Select is located under the 4-20mA module setup. This is where we define the input channel and select the VPS. Go to the 4-20mA Module setup and make the following changes. If Electronic Line Leak detection is being installed, some channels will be used for the LLD transducers.

Group Name	Parameter Name	Parameter Value	Explanation	
4-20mA Input Modules				
	Module #	Channels	(n)	Select "1" for the Vapor Pressure Sensor
	Channel #	Name	Ex. ISD Pressure Sensor	Unique name for VPS
		Enabled	Yes	Keep as "Yes"
		Service Type	Vapor Recovery Monitor	Select correct service type for application

Remote ATG Serial Port Settings

If the Console will be getting ullage volume from a Remote ATG then the serial port must match that of the other tank gauge.

Group Name	Parameter Name	Parameter Value	Explanation	
Power Supply Module				
	COMM 2	Baud Rate	9600	Set to match External ATG
		Data Bits	8	Set to match External ATG
		Parity	None	Set to match External ATG
		Stop Bits	1	Set to match External ATG
		Response Timeout	8	Leave as default

Relay Mapping

Relay mapping is necessary for proper shutdown of dispensers. The programming of the Relay Module will tell the VRM which Vapor Flow Meter will control which Dispenser. As you will see this is why we enter a unique name for each Flow Meter so we can easily identify the channel.

Note: By mapping the relay to the VFM in the following setup, we now enable the VRM to automatically shutdown dispensing upon ISD alarms.

Group Name	Parameter Name	Parameter Value	Explanation	
Relay Module				
	Module #	Channels	(n)	Select number of dispensers
	Channel #	Name	Dispenser 1 Power	Unique name for relay's purpose
		Enabled	Yes	set to "Yes"
		Type	Dispenser	
		Polarity	Normal	Set to Normal
		Logic	OR Logic	Set to OR
		Physically Wired As	Normally Closed	Set to Normally Closed
		Number of Inputs	1	Set to 1
	Input 1	Type	Probe Module	Select Probe Module
		Channel	VFM Disp 1	Select the VFM associated with this Dispenser

Additional relays may be used for other purposes such as submersible pump control or external alarms. See the *TS-5xxx Installation Guide* (p/n 000-2150) for more information.

Dispenser Interface

The Dispenser Interface setup is where the Dispenser Interface Module is programmed. For this setup, you will need to know what kind of D-Box the Dispenser Interface module is connecting up to and what type of communication interface it is using. For more information on the installation and setup of the Dispenser Interface Module, see the TS-5xxx Installation Manual and TS-5xxx Setup and Programming Manual.

Group Name	Parameter Name	Parameter Value	Explanation	
Dispenser Interface				
Precision	Volume Precision	3	Leave as default	
	Dispenser Volume	Gross	Leave as default	
Grades	Number of Grades	3	Select number of different gasoline only grades at facility	
	Grade 1	Name Include in Vapor recovery	Regular Unleaded Yes	Enter a Name for the Grade
	Grade 2	Name Include in Vapor recovery	Premium Unleaded Yes	Enter a Name for the Grade
	Grade 3	Name Include in Vapor recovery	Super Unleaded Yes	Enter a Name for the Grade
Dispenser Interface Modules				
DIM 1	Type	Wayne		
	Communication	Current loop		
Fueling Points	Number of Fueling Points	12	Enter the number of gasoline fueling points	
Fueling Point 1	Number of Hoses	3		
	Hose 1 QC	Grade Association	Regular Unleaded	Enter a Name for the Grade
Position		0	Select position of Grade	
Hose 2	Grade Association	Premium Unleaded	Enter a Name for the Grade	
	Position	1	Select position of Grade	
Hose 3	Grade Association	Super Unleaded	Enter a Name for the Grade	
	Position	2	Select position of Grade	
Fueling Point 2	Number of Hoses	3		

Vapor Recovery Monitoring Setup

This is the final setup to get the Vapor Recovery Monitor (VRM) to work properly. This is where we select the type of vapor recovery system and call in the appropriate external sensors.

Group Name	Parameter Name	Parameter Value	Explanation	
Vapor Recovery Monitor				
	Method Type	Balance or Assist	Select the type of EVR system installed.	
	Hour Assessment	0	Set time of VRM alarm action	
	Week Day Assessment	Sunday	Set Day of VRM alarm action	
Dispenser Configuration	Dispenser Type	Wayne or Gilbarco	Select the dispenser model	
	Multihose Dispenser Site	No	Select yes or no	
	Number of Dispensers	0 (1 to 48)	Equal to the number of flow meters installed	
	Dispenser 1	Flow Meter	Unique Name	Select Meter by name from list of enabled meters
		First Fueling Point	1	Select correct fueling points for dispenser number.
	Second Fueling Point	2	Select correct fueling points for dispenser number.	
Ullage Pressure Input	Sensor	Sensor name	Select the correct sensor name	
Ullage Volume Input	Acquire Ullage	Internal, external	Select internal if using LL2 probes or external if connected to remote ATG.	
	Security Code	#		
	Number of tanks			
Tank 1 Ullage	Enabled	Yes or No	Select Yes if part of EVR System	
	Tank 2 Ullage	Enabled	Yes or No	Select Yes if part of EVR System
Pressure Management System	Enabled	Yes or No	Yes	
	Type	Clean Air Separator	Select appropriate device	

Managing Rules

Alarms will be generated automatically and can be seen on the touchscreen display or the Alarm pages on the web browser. These alarms can be programmed to generate various outputs based on the Rules setup.

Note: VRM alarms will automatically disable dispensers and this feature cannot be turned off per CP-201 requirements.

Additional actions can be created by setting up Rules. Rules are the way to create actions and notifications based on specific events change. Events are the inputs to the rule, for example it can be a failed test or a sensor gone bad, but it can also be a simple test completion notification. Actions are the outputs for the Rules, for example you can program the console to send emails, trip relays, or sound alarms. The Rules are entirely flexible and allow stations owners to customize the alarm notification process.

There are three default rules enabled on the Console. These rules all have actions to sound the internal audible alarm. These rules can be disabled or can have their action changed. New Rules can be added for complete customization for notification. Below is an example of a new rule that emails a notification on any new VRM alarm. A more descriptive explanation on Rules can be found in the *TS-5xxx Programming Guide* (p/n 000-2142).

Rules

Variable	+ or -	Explanation
Rules	+	
Rule – Power On »		Default Rule, Internal audible alarm output
Rule – Application Events »		Default Rule, Internal audible alarm output
Rule – New Alarm Occurred »		Default Rule, Internal audible alarm output
Rule – New Rule #1	-	
Name		Enter a name for the rule. Once entered, the name will appear next to the above Rule.
Enabled		Select whether the rule is to run or not
Events	+	By pressing the + sign, you can have one or multiple events
Event	-	Below is an example of a new rule to send an email for any new VRM alarms
Type		Select “New Alarm Occurred”
Category		Select VRM
Code		Select “Any”
Device		Select “Any”
State		Select “Active”
Actions	+	
Action	-	
Type		Select “E-Mail” (See next section for setting up email notification)
Address		Enter in your email address
Content		Select “Generated” to have the Console automatically produce the contents in the email. Otherwise you can have the email contain exactly what you specify.
Template		Select “HTML”. You can have either a text or HTML email.

Setting Up E-mail Notification

The E-mail notification is a feature that allows store owners and managers to receive e-mails from their console. These e-mails include alarms, events and test results. In order for the system to send e-mails and text messages based on the Rules configurations, certain parameters need to be configured. These parameters will tell the console how to transmit e-mails to the outside.

Email

Variable	Description
"From" Address	Unique e-mail address to identify the VRM console (e.g. Site@city.state)
SMTP Host	This is to be provided by network administrator or ISP
SMTP Port	Check with network administrator or ISP
Enable Authentication	Some e-mail providers require authentication in order to send e-mails. See Internet Service Provider
Maximum Queue Size	The number of e-mails that can be waiting to be sent
Retry Timeout	The number of seconds to wait between failed tries. Default is 3600 seconds or 1 hr.
Watchdog Timeout	This is the inactivity timeout.

System Operation

Run-Time Status

The VRM application has several useful run-time menus to check status or to get current test status.

Home»Status

The home-status page shows the current status of all applications running in the Console, see Figure 3. Depending on the applications that are running on the console, the Home-Status will display only the ones enabled. In Figure 3 below, we have FMS (Fuel Management System), and VRM (Vapor Recovery Monitoring). At anytime you can get to the Home Status menu by pressing the **Home Box**.

Figure 3 – Home Status LCD View

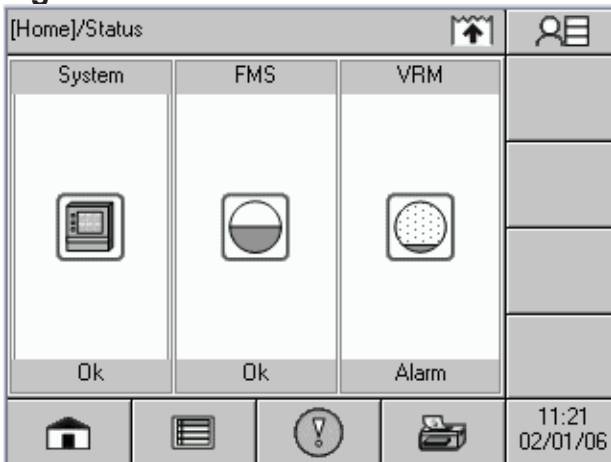

System»Status

The System-status window shows the state, slot location, and module version number of each module inside the physical console.

VRM»Status

The VRM-Status window gives the current status of each Vapor Flow Meter, pressure sensor, and other VRM related data. See Figure 5b.

Vapor Recovery Web Pages

VRM Status Page (Web Page View)

The **VRM»Status** page will show up to date status for each fueling point. The status is based on the previous days results. In the Current Status column a Pass (✓), Failure (X), Warning (!), or Insufficient (*) symbol will show up for each fueling point. The final assessment for each fueling point will occur at the end of the day and can be viewed in the ISD reports. The following describes the remaining information in the VRM status page. Refer to Figure 4 - VRM Status Page.

Auto Refresh: The LCD automatically refreshes the screen with the latest data. Using the web version, the VRM Status page has an optional Auto Refresh mode and can be enabled by selecting the "Auto Refresh" link in the upper right-hand corner. The default refresh rate is set to 30 seconds but can be changed to a faster or slower rate. To change the refresh rate go to the **Preferences** page.

Dispenser: This is the dispenser number as associated with the Point of Sale system.

Dispenser Status: Shows the activity of the dispenser, Idle (or inactive), Dispensing, or Shutdown. This status is linked to the dispenser hook signals only.

TS-VFM: Shows the state of the vapor flow meters and is only in the web-based view. There are four possible states:

Operational – The VFM has no alarms

Missing – The VRM has lost communication with the vapor flow meter. This may occur during an open circuit or the vapor flow meter is not installed on the port in which it was programmed for.

No Data – The VRM is unable to understand the input data. This may occur when a port is programmed for a flow meter but a magnostrictive probe is connected instead.

Error – The flow meter data was not sent correctly. This may occur when with excessive noise in the system or it is an indication that the flow meter is not functioning correctly.

Fueling Point: This is the assigned fueling point number from setup.

Daily Status: The daily status shows the last completed daily assessment for each fueling point/hose. One of four symbols will be displayed for each fueling point/hose.

Weekly Status: The weekly status shows the last completed weekly assessment for each fueling point/hose.

Last A/L: This value is the fueling point's last calculated A/L ratio result. The value is based only on a single transaction.

Figure 4 - VRM Status Page

Franklin Fueling Systems		VRM Status				
Home System VRM Setup Preferences						Auto Refresh
Status Alarms Control Reports						07/13/2009 12:13:49
Dispenser	Dispenser Status	TS-VFM	Fueling Point	Daily Status	Weekly Status	Last A/L
1	Idle	Operational	1	✓	✓	0.49
			2	✓	✓	1.01
2	Dispensing	Operational	3	✓	✓	0.55
			4	✓	✓	0.68
3	Idle	Operational	5	✓	✓	0.33
			6	✓	✓	0.31
4	Idle	Operational	7	✓	✓	0.55
			8	✓	✓	1.12
5	Idle	Operational	9	✓	✓	0.47
			10	*	✓	0.39
6	Idle	Operational	11	✓	✓	1.12
			12	*	✓	1.20
Common					Value	
Pressure Sensor					Operational	
Ullage Pressure					-7.86	
Weekly Ullage Pressure Leak Test					Pass	
Weekly Ullage Pressure Monitoring					Pass	
Monthly Ullage Pressure Monitoring					Pass	
Operation Time %					100	
Pass Time %					100	
Readiness State					Ready	
Algorithm Version					1.2.0	
Collection Method					Assist	

pass ✓ fail ✗ warning ! insufficient * disabled ☒

VRM Status (LCD View)

The LCD view provides the same information as the web page but is broken into two different screens. The VRM-Status on the LCD will show the real time information for the ullage pressure and last run pressure test results as shown in Figure 5a & 5b. The VRM-Dispenser is the second screen which shows current status of the dispensers as shown in Figure 6a & 6b.

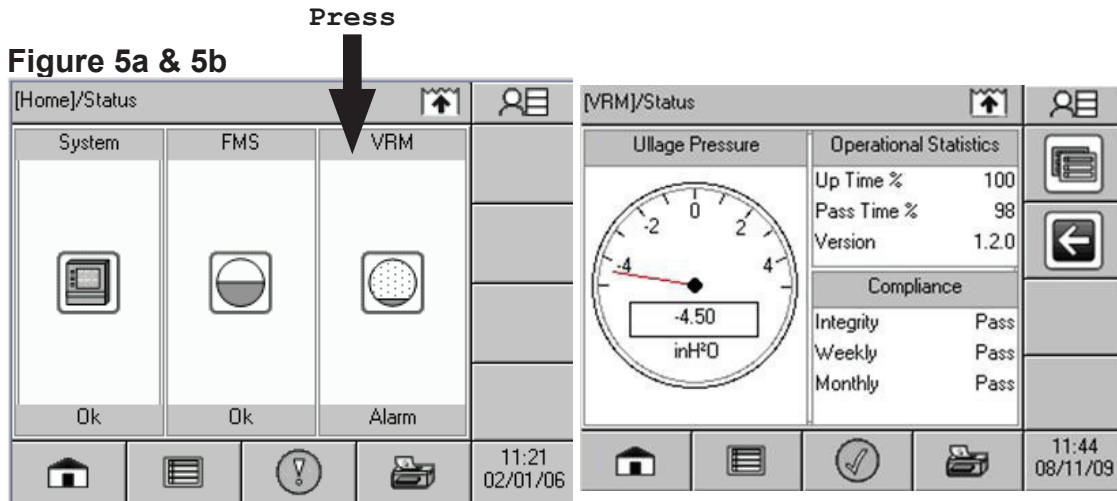

VRM»Dispensers (LCD View)

By pressing the Application Menu button  in the upper right-hand corner of the **VRM»Status** screen it will bring you to a page of several submenus for VRM. The Status box is the same page as shown in Figure 5b. The Dispensers page will bring up a new page that looks like the one in Figure 6b.

Figure 6a & 6b



VRM»Alarms Page (LCD View)

The **VRM»Alarms** page shows all current alarms for the Vapor Recovery Monitor. When an alarm clears it will be removed from this page but will be kept in memory. The Alarm History report will provide information on previous alarms.

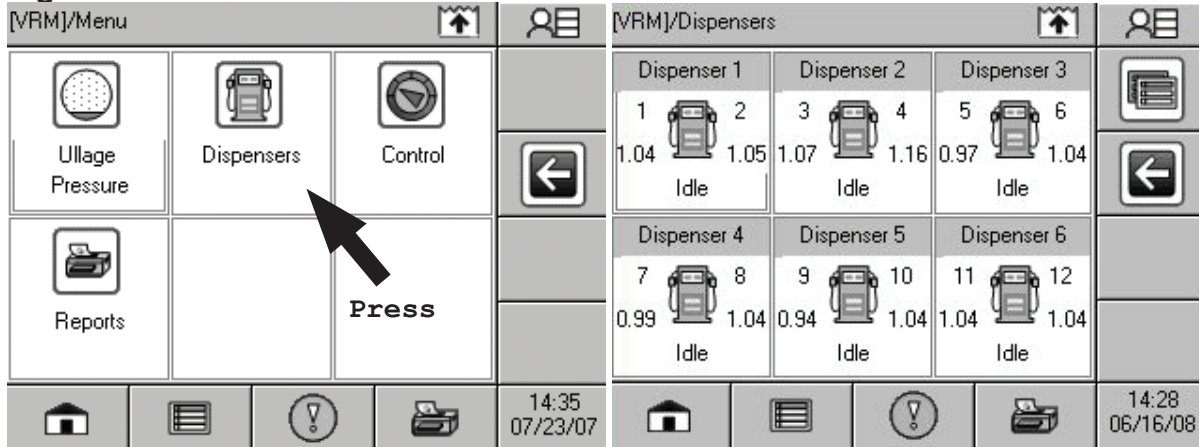

Press

Status	Alarm Description	Timestamp
V	FP 12 Warning	10/18/05 00:18
R	Daily Vapor Collection	
M		
V	FP 9 Warning	10/18/05 00:18
R	Daily Vapor Collection	
M		
V	FP 8 Warning	10/18/05 00:18
R	Daily Vapor Collection	
M		

VRM»Control (LCD View)

The VRM control page is setup to run manual test and calibrate the pressure sensor. These features are described later in this manual.

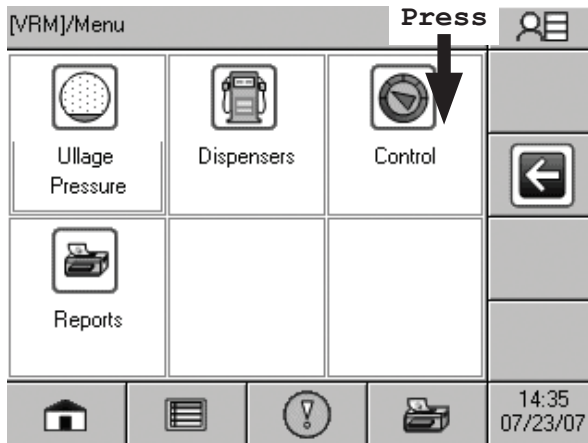

Press

Alarms, Warnings, and Failures

Alarms, warnings, and failures are designed to alert you with specific details when a problem occurs so that you can take appropriate corrective action. System alarms, VRM alarms, VRM warnings, and VRM Failures will always notify the user in certain ways, other notification options are programmable.





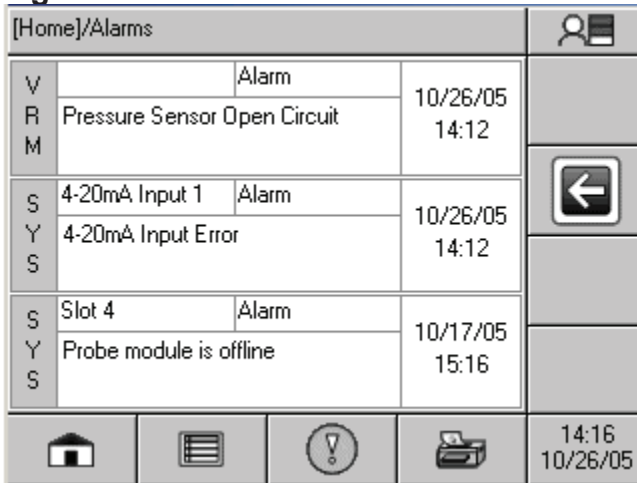

Figure 7 shows an example of two System Alarms, and one VRM alarm. All active alarms can be viewed from the LCD by pressing the Alarm button, , at the bottom of the LCD. Once the alarm goes inactive it will disappear from the **Home/Alarm** page but will remain stored in memory. Any outputs that are programmed to activate based on alarms will go active. These outputs can be customized to activate based on specific alarms or all alarms in the Rules setup.

System Alarms

System alarms are non-application related alarms. These alarms are usually related to hardware such as an internal module is offline or a printer problem.

Figure 7



[Home]/Alarms				
V R M	Alarm	10/26/05 14:12		
Pressure Sensor Open Circuit				
S Y S	Alarm	10/26/05 14:12		
4-20mA Input 1				
4-20mA Input Error				
S Y S	Alarm	10/17/05 15:16		
Slot 4				
Probe module is offline				
				14:16 10/26/05

VRM Alarms

Vapor Recovery alarms are hardware problems related to the Vapor Recovery Monitoring application. VRM alarms will be generated immediately with a flashing RED LED. A VRM alarm will not cause a dispenser(s) shutdown.

VRM Warnings and Failures

VRM Warnings and Failures are monitoring alarms related only to the Vapor Recovery Monitoring application. These Warnings and Failures are directly related to the CP-201 ISD requirement to monitor collection and containment of the vapor recovery system. A VRM warning will occur when either a fueling collection point or the entire vapor containment does not meet the operating thresholds. A warning is the first sign of a vapor recovery problem. A VRM failure will follow the warning if the specific problem with the vapor recovery component does not get fixed within the monitoring time period. This failure will cause either a single or site shutdown, depending on the type. The following provides more detail on the specific warning and failure types.

Vapor Collection Warning and Failure

Vapor collection warning and failures (A/L) generally occur due to poor or no vapor being returned to the underground storage tank during fueling transactions. The VRM system makes both a daily and weekly assessment on the quantity of the vapor collection. If the collection is below the lower failure limit or above the higher failure limit, then the VRM will go into alarm.

Upon a Vapor Collection Warning condition, it is highly recommended to get the fueling point(s) serviced as soon as possible. If a fueling point goes untreated, then the VRM will issue a failure alarm and shut down the affected dispenser. If this condition occurs, the entire dispenser should be placed out of service until a Franklin Fueling Systems certified technician can troubleshoot the problem. All other dispenser will remain in operation. See Appendix A for the Alarm Code description and possible solution, or the *Vapor Recovery Monitoring Troubleshooting and Diagnostics Guide* available on the Franklin Fueling Systems Web site: www.franklinfueling.com.

Vapor Pressure Containment Warnings and Failures

A Weekly or Monthly Ullage Pressure warning or failure occurs when the vapor pressure exceeds the operating threshold. The VRM system makes both a weekly and monthly assessment on the amount of time the vapor containment pressure exceeds a threshold over a specific period of time. If the containment pressure rises above the overpressure limits for either the weekly or monthly thresholds, then the VRM will issue a warning. A second consecutive period of exceeding the overpressure threshold will result in a failure alarm and a shutdown of all dispensers.

A Weekly Ullage Pressure Leak Test warning or failure is an indication that the containment space (vapor space) is leaking vapors beyond the allowable limit. This assessment is performed on a weekly basis. If a vapor containment is leaking, the VRM will issue a warning at the end of the first week and if it is not fixed by the end of the second week then all dispenser will become disabled.

See Appendix A for the Alarm Code description and possible solution, or the *Vapor Recovery Monitoring Troubleshooting and Diagnostics Guide* available on the Franklin Fueling Systems Web site: www.franklinfueling.com.

Re-enabling Dispenser(s)

Dispensers can be re-enabled by the following method. Note that this procedure does not clear any warnings or failures, it only re-enables dispensing.

Warning  **The Failed fueling point requires immediate attention and should be bagged so it is not used until the problem has been fixed by a certified Service Technician. Continuous use of a failed Fueling Point will result in another shutdown.**

Warning  **Refer to local districts before putting a shutdown dispenser back into operation.**

From the LCD:

1. Go to the **VRM»Dispensers** menu (see Figure 5a & 5b and Figure 6a & 6b).
2. Press the dispenser showing “Shutdown”.
3. Press “Yes” on the confirmation box.

From the Web Browser:

1. Go to the **VRM»Status** page.
2. Press the red “Shutdown” for each dispenser showing shutdown.
3. Press “Yes” to enable the dispenser or all dispensers.

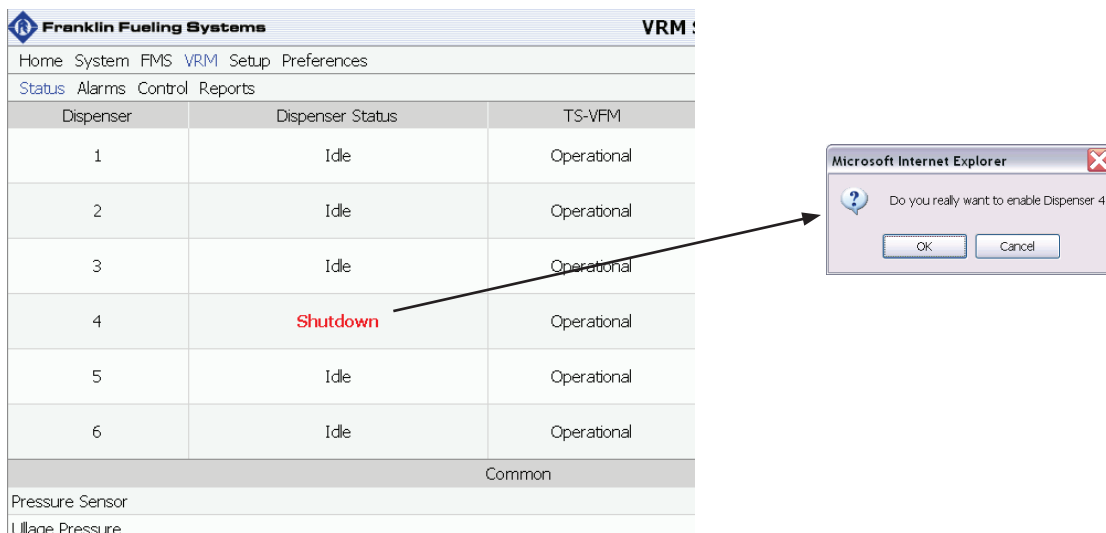

Dispenser	Dispenser Status	TS-VFM
1	Idle	Operational
2	Idle	Operational
3	Idle	Operational
4	Shutdown	Operational
5	Idle	Operational
6	Idle	Operational

Common

Pressure Sensor
Ullage Pressure

Note: If a dispenser shutdown was caused by poor vapor collection, you will only be able to enable one dispenser at a time. If the shutdown was caused by a pressure failure, you will be able to enable all dispensers at the same time by pressing any dispenser.

Clearing Alarms

Vapor Flow and Vapor Pressure alarms can be cleared by running the respective manual test or by waiting until the next assessment period has passed.

Clearing Vapor Collection (A/L) Alarms

Once a certified technician has fixed the cause of the vapor flow problem, the alarm can be cleared by two methods: running a manual test or letting the fueling point go through a full day of transactions. The manual A/L test is much faster and will allow the technician to clear the alarm before leaving the site. To run a manual test, go to **VRM»Control** then select “**Manual A/L Test**”. Now select the fueling point(s) that are in alarm and on the next dispense, if there is an A/L passes then the alarm will clear. See Figure 8a & 8b.

Figure 8a & 8b

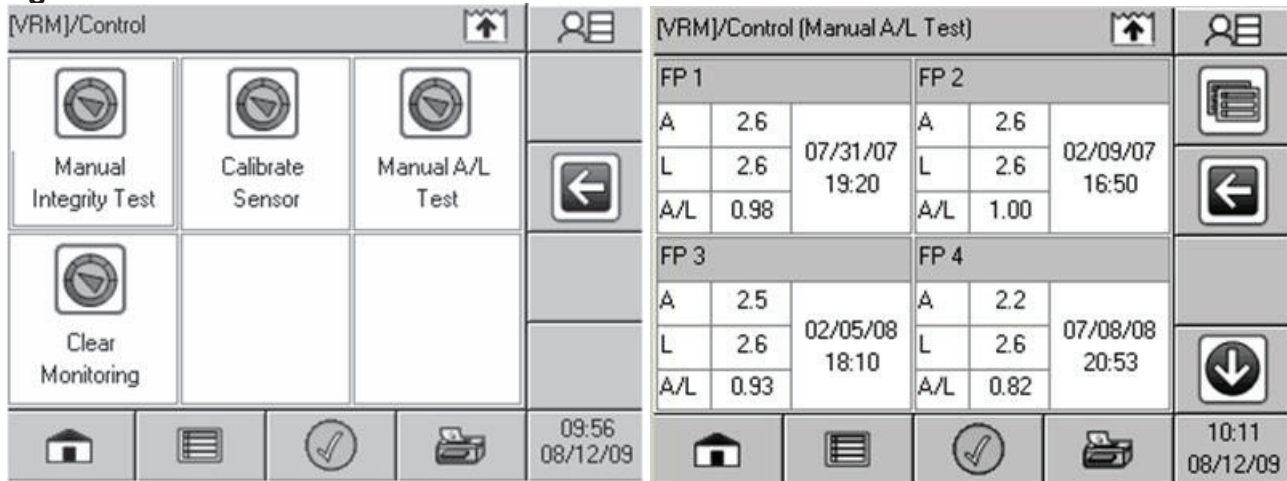

Note: The manual A/L test should be done on either a known non-ORVR vehicle or test container that will return air/vapor mixture back to the UST. If the A/L does not meet the required threshold then the fueling point will remain in alarm.

Clearing Pressure Related Alarms

A technician will also have two methods of clearing pressure related alarms by either letting the system go through its normal assessment period or manually clearing pressure alarms.

To clear a Pressure Related Alarms, do the following:

1. Go to the **VRM»Control** Page and select “**Clear Monitoring**”.
2. Enter in your Franklin Fueling Systems technician ID number.
3. Enter in the administrator password.
4. All the Pressure Monitoring Alarms shall clear.

Reports & Printing

Creating Reports

Reports can be generated and printed based on the last 30 days, by month, or by year. The console stores ISD history for two years.

Figure 9a and 9b - VRM Reports LCD View

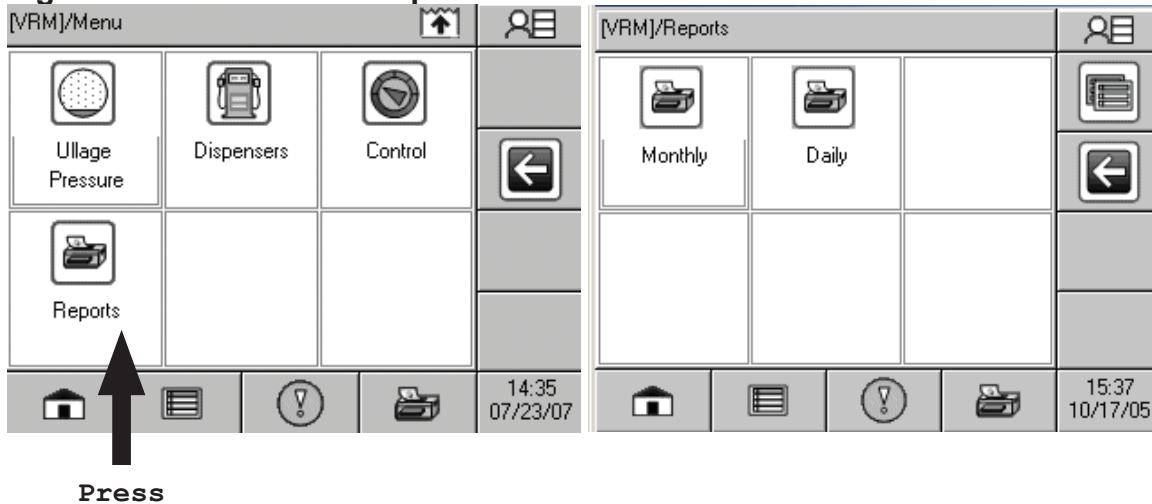

Alarm Reports

Alarm reports can be generated either from the **System»Reports** page or the **VRM»Alarms** web page. The **System»Reports** page will generate both the system alarms and application alarms while the **VRM»Alarms** will only generate VRM related application alarms.

VRM Reports

There are two different VRM reports that can be generated, a Daily Report and a Monthly Report. The Daily Report generates a list of results for each day on a rolling 30 day basis. The information included in the report is:

Daily Report

ISD Up-Time

The ISD up-time is the percentage that the ISD System is running the VRM application. It calculates the up-time based on actual run-time during a 24-hour period. It is stated in CP-201 that the ISD system must be running 95% of the time on an annual basis.

Highest and Lowest Ullage Pressure

The highest and lowest ullage pressure is the highest and lowest average hourly pressure for each day.

75th and 95th Percentile Ullage Pressure

The VRM records and stores the 75th and 95th highest ullage pressure for each day.

Fueling Point Assessments

This shows the daily status of each fueling point. There are four assessments that each fueling point can be classified into; pass, failure, warning, or insufficient data.

Monthly Report

ISD Operation Time, %

The ISD operation time is the cumulative operation time of the VRM application. It is stated in CP-201 that the ISD system must be running 95% of the time on an annual basis.

EVR Operating Requirements

The EVR operating requirements list what EVR components are installed at the site and what each component should be operating at if applicable.

EVR Pass Time, %

The EVR pass time is the percentage of time the entire EVR system is not in an Alarm state.

ISD Monitoring Requirements

The ISD monitoring requirements are the limits in which alarms are triggered by.

Warning, Failures

This is a list of current and past warnings and failures that relate to VRM.

Event Log

The event log shows a description of any shutdowns and the action to re enable any fueling points.

Printing Reports

Printing from a Web Browser

Printing reports can be done directly from the web browser. Once a report is generated it can simply be printed by going to the **File>Print** on the on the web browser's tool bar.

Printing from the Local LCD

To print from the local LCD to the internal printer, press the print button  and it will navigate you to the print menu. From the print menu, you can choose the type of report you want to print.

Printed VRM Report Examples

```

{Site Name}
{ID Line 1}
{ID Line 2}
{ID Line 3}
{ID Line 4}
{ID Line 5}
12/26/2008      11:25:39

VRM Daily Report
From: {date}
To:   {date}

Pressure: inH2O
ISD Version: 1.2.0
ISD Up Time 100%

12/26/2008
ISD Up Time      100.00
ISD Pass Time    0.00
Pressure Max     0.26
Pressure Min     -2.53
Pressure 75th   -0.77
Pressure 95th   -0.11

FP1      P0.98
FP2      P1.03
FP3      P1.03
FP4      P1.05
FP5      P0.98
FP6      P1.01
FP7      P1.01
FP8      P1.05
FP9      P0.97
FP10     P1.02
FP11     P1.03
FP12     P1.05

12/25/2008
ISD Up Time      100.00
ISD Pass Time    0.00
Pressure Max     0.22
Pressure Min     -2.67
Pressure 75th   -0.90
Pressure 95th   -0.21
FP1      P0.98
FP2      P1.03
FP3      P1.03
FP4      P1.05
FP5      P0.98
FP6      P1.01
FP7      P1.01
FP8      P1.05
FP9      P0.97
FP10     P1.02
FP11     P1.03
FP12     P1.05
    
```

```

{Site Name}
{ID Line 1}
{ID Line 2}
{ID Line 3}
{ID Line 4}
{ID Line 5}
12/20/2005      11:25:39

VRM Monthly Report
From: {date}
To:   {date}

Statistics
December 2005
Operation [%]
100
Pass [%]
100

Operation Requirements
Vapor Collect Method
Assist
A/L Low
0.95
A/L High
1.15

Monitoring Requirements
Dry Vapor Coll. A/L
Low
0.33
High
1.90

Wkly Vapor Coll. A/L
Low
0.81
High
1.32

Wkly Ullage Press. Mon.
High
1.30

Mthy Ullage Press. Mon.
High
0.30

Warning Alarms
Occurred
12/09/2005      00:05:00
Cleared
12/10/2005      02:15:00
Daily Vapor Collection
Fueling Point 10

Failure Alarms
11/27/2005      00:00:05
Weekly Ullage Pressure Leak

Events
Occurred
12/20/2005      07:07:14
    
```

Maintenance

General Inspection

Maintenance is not required on the ISD equipment. All ISD Vapor Flow Meters and Vapor Pressure Sensors are checked every day for proper operability. The Console also does a self-check on all the internal modules as well on a daily basis.

If the Console identifies a problem with any components or Vapor Recovery Sensors, they will need to be diagnosed. See the replacement part numbers for the failed component and contact Technical Service.

Console and Vapor Recovery Equipment Replacement Parts

Part Number	Description
TS-PRB	12 Input Probe Module
TS-420IB8	8 Input 4-20ma Module
TS-RLY	8 Channel Relay Module
TS-ACI	12 Channel AC Input Module
TSSP-CM	Control Module
TSSP-PS	Power Supply Module
TSSP-LCD	LCD Display
TSSP-IFB5X	TS-550/EMS Interface Board
TSSP-IPPTR	Impact Printer Assembly
TSSP-T550MB	TS-550/EMS Motherboard
TSSP-T5000MB	TS-5000 Motherboard
TS-VFM	Vapor Flow Meter
TS-VPS	Vapor Pressure Sensor
TS-DIMIB	Internal Dispenser Interface Module
TSP-ENCD	Flow Meter Encoder Replacement
TSSP-BAT	3V Lithium Battery
TSSP-F4	Fuse, 3A (Relay and Power Supply)
TSSP-ISBS	I.S. Barrier Shield
TS-TP5000	TS-EMS/550/5000 Impact Printer Paper
TS-INKRB	TS-EMS/550/5000 Inker Ribbon
TSSP-TRMBLK	Package of 10 Terminal Blocks
TSSP-TMPTR	Thermal Printer
TS-TP2	Paper for the Thermal Printer (1 box of 5)

Diagnostics

Pressure and Transaction Log Files

The console records pressure and transaction data on a continuous rolling basis. There are two .csv (comma separated values) files that can be downloaded from the VRM download page. These files are Microsoft Excel compatible and can be used as a diagnostics tool to help troubleshoot sites.

Note: This feature is only available in VRM Version 1.2.0 or higher.

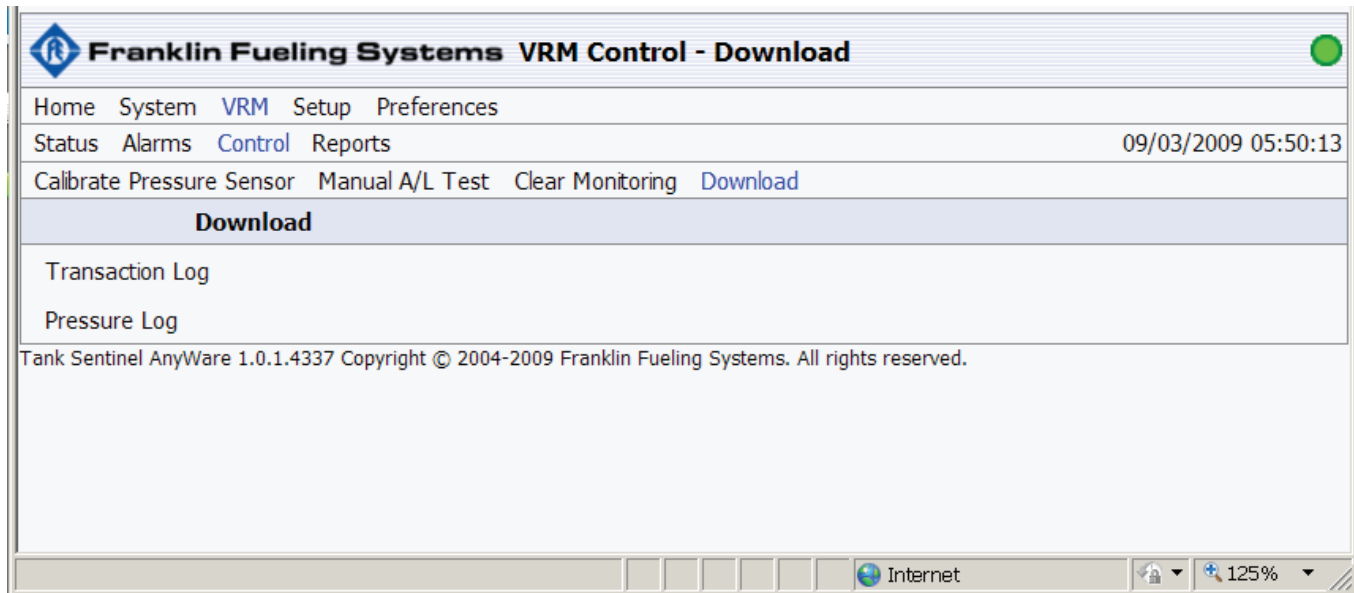

Pressure Log Files

The pressure log file contains 2 weeks of pressure samples in one minute increments. Below is an explanation of the columns in the pressure log file.

Term	Description
DATE_LOCAL	This column is the date the pressure sample was recorded.
TIME_LOCAL	This column is the time the pressure sample was recorded.
QUIET_TIME	This value indicate if there was active dispensing at the time of the sample. A "1" indicates at least one fueling point is dispensing and a "0" indicates no fueling points are dispensing.
PRESSURE	This is the pressure sample recorded by the console. The Vapor Pressure Sensor has a range between -8 Inches WC and +8 Inches WC. The pressure value may reach as far as 9 Inches WC, this is ok.
ULLAGE	The ullage is the amount of vapor space in the vapor containment area. The units are in gallons.

	A	B	C	D	E	F
1	DATE_LOCAL	TIME_LOCAL	QUIET_TIME	PRESSURE	ULLAGE	
2	8/15/2009	20:05:00	0	-8.92	19645	
3	8/15/2009	20:06:00	0	-8.92	19645	
4	8/15/2009	20:07:00	0	-8.90	19646	
5	8/15/2009	20:08:00	0	-8.90	19646	
6	8/15/2009	20:09:00	0	-8.88	19646	
7	8/15/2009	20:10:00	0	-8.84	19646	
8	8/15/2009	20:11:00	0	-8.84	19646	
9	8/15/2009	20:12:00	0	-8.84	19646	
10	8/15/2009	20:13:00	0	-8.82	19646	

Transaction Log Files

The transaction log file records and stores 1000 transactions per fueling point.

Term	Description
HOSE	This column indicates the hose or fueling point number the transaction occurred on. The value shown is a combination of fueling point number and hose number. The right two digits indicate the hose number and the left digits indicate the fueling point number. For uni-hose dispensers, the right two digits can be ignored. You will see a 100 for fueling point 1, 200 for fueling point 2, etc. For multi-hose dispensers, you will see values such as 101 indicating fueling point 1 hose 1 or 703 indicating fueling point 7 hose 3.
DATE_LOCAL	This column is the date at the beginning of the transaction.
TIME_LOCAL	This column is the time at the beginning of the transaction. The time is a local reference to the console.
AIR_VOLUME	This column is the air or vapor returned through the ISD flow meter. The units are in gallons.
LIQUID_VOLUME	This is the amount of gasoline that was dispensed during the transaction. The units are in gallons.
RATIO	This is the A/L ratio of the transaction.
TYPE	This is the classification of the transaction. Only v_VRMValidAoL type transactions are used as part of the daily and weekly average: v_VrmValidAoL is a single transaction that was either less than 0.15 or greater than 0.50. v_VrmORVRPotential is a single transaction that was between 0.15 and 0.50. v_VrmMultipleTransactions is when both sides of a dispenser were active at the same time. v_VrmDispenseVolumeZero occurs when no liquid volume is dispensed. This may occur when a transaction is aborted before pumping any fuel. v_VrmSmallFuelVolume occurs when less than 1 gallon of gasoline is dispensed. v_VrmTransactionLost occurs when the console does not receive the volume of gasoline dispensed from the dispenser or a new transaction occurs too quickly. v_VrmReferenceTest is assigned to a transaction when the transaction is being run as part of a Manual A/L. This is usually done when clearing vapor collection alarms.

Below is an example of a transaction log file.

	A	B	C	D	E	F	G
1	HOSE	DATE_LOCAL	TIME_LOCAL	AIR_VOLUME	LIQUID_VOLUME	RATIO	TYPE
2	101	8/15/2009	20:16:13	6.43	6.46	1.00	v_VrmValidAoL
3	301	8/15/2009	20:18:28	3.88	17.82	0.22	v_VrmORVRPotential
4	703	8/15/2009	20:19:41	3.71	3.45	1.08	v_VrmValidAoL
5	802	8/15/2009	20:21:31	1.57	5.17	0.30	v_VrmORVRPotential
6	401	8/15/2009	20:21:52	0.52	3.23	0.16	v_VrmORVRPotential
7	201	8/15/2009	20:23:28	2.68	4.68	0.57	v_VrmValidAoL
8	101	8/15/2009	20:25:47	12.42	13.53	0.92	v_VrmValidAoL
9	701	8/15/2009	20:25:53	2.22	6.45	0.34	v_VrmORVRPotential
10	101	8/15/2009	20:30:22	10.77	12.91	0.83	v_VrmValidAoL
11	201	8/15/2009	20:32:58	3.95	10.63	0.37	v_VrmORVRPotential
12	501	8/15/2009	20:34:02	16.53	20.12	0.82	v_VrmValidAoL
13	401	8/15/2009	20:34:28	2.62	14.04	0.19	v_VrmMultipleTransactions

Steps to download log files

1. Navigate to the VRM>Control>Download web page.
2. Click on either the Transaction Log file or Pressure Log file.
3. A message box will appear asking if you want to Open, Save, or Cancel. If you choose to save, you will be prompted to save it to a directory of your choice. The file may take up to five minutes to completely download.

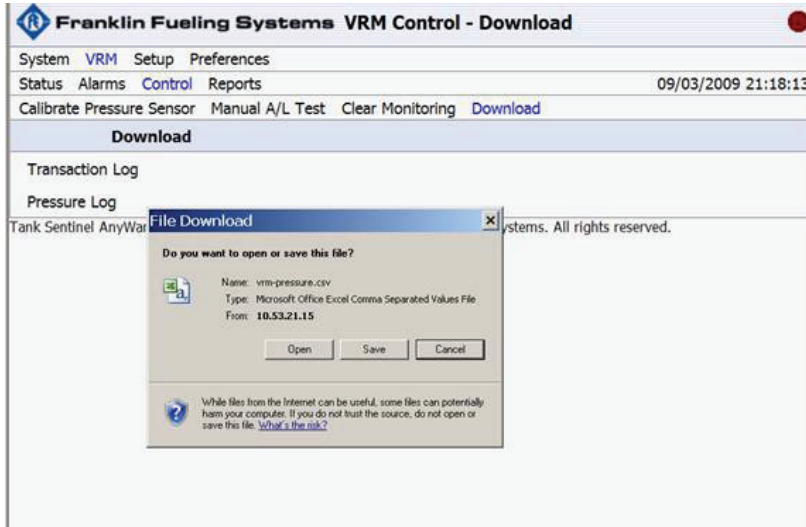

4. Once downloaded, the file can be opened by double clicking on it. The file is best viewed when Microsoft Excel is installed on the PC.

START-UP/NEW INSTALLATION FORM
INCON VAPOR RECOVERY MONITORING (VRM) SYSTEM

DATE _____

INCON VRM Startup Checklist

Service Company Name	Telephone Number
Service Technician	INCON Tech Cert #
Station Address	City
Phase I EVR Equipment Manufacturer	Phase II EVR Equipment Manufacturer

Dispenser Equipment Checklist		YES	NO	Initials
1	Franklin Fueling Systems, . Healy Phase II EVR System including ISD System installed according to CARB E.O. VR-202?			
2	Is the Vapor Pressure Sensor test port installed in the correct direction? When the ball valve is closed it should isolate the Vapor Pressure Sensor from the containment area. See Figure 11 of the procedure. If it is not then it must be configured such that the pressure sensor is isolated when the valve is closed.			
3	Is the Pressure Sensor in the Open position with the plug in the test port? See Figure 11 of the procedure.			
4	Was Oil and gasoline compatible PTFE Tape used on the threads for the Vapor Flow Meter rather than pipe dope?			
5	Was a pressure decay test run per TP201.3?			
6	Was the Dispenser Vapor Line Integrity Test run to check for leaks in the dispensing equipment?			

Tank Sentinel Equipment Checklist		YES	NO	Initials
7	Was the dispenser maximum load current measured and recorded? Be sure the proper size Relay Module is used. Use the 10A Relay Module if the current exceeds 2 Amps.			
8	Were the Gasoline Dispenser Hook Signals wired individually to the AC Input Module with dispenser 1 wired to the first set of channels? Verify all non-gasoline hook signals are installed after the last gasoline hook signal.			
9	Has the Administrator Password been set?			
10	Was the External ATG alarm able to be generated and cleared?			

Appendix A: Alarm Codes

Device	Description	Category	Type	Definition	Possible Cause and Solution
Fueling Point [n]	Daily Vapor Collection or Weekly Vapor Collection ¹	VRM	Warning or Alarm	This Vapor Recovery alarm occurs when the vapors being return to the UST are blocked. The alarm will occur either at the end of the day or the end of the week depending on the type of vapor recovery system is installed.	May be caused by leaking hanging hardware, blocked hoses or vapor recovery lines, jammed flow meter. Run Exhibit 5 of VR-202 to verify a blockage. Check for leaks by viewing the vanes through the site glass on the VFM.
	Weekly or Monthly Ullage Pressure ¹	VRM	Warning or Alarm	This vapor recovery alarm occurs when the UST ullage pressure exceeds the alarm threshold for the time period specified in the alarm.	Look for problems using one or more of the following VR-202 procedures/ tests: Dispenser Integrity Test B-3m (i.e. "Plumbing Tightness test), Exhibit 4, Exhibit 5, Exhibit 9 (pressure sensor only) or flow rate verification per section 1.2.3.
	Weekly Ullage Pressure Leak Test ¹	VRM	Warning or Alarm	This vapor recovery alarm occurs when the Vapor Recovery Monitor determines a leak greater than the allowable.	May occur when there's an excessive leak in the vapor recovery containment area. Perform a pressure decay test per TP-201.3.
Channel [n]	Missing	VRM	Alarm	A flow meter is not connected or there is an open in the wiring. This will only occur for a flow meter channel that is programmed to have a flow meter.	Check the connection. Measure the voltage of the terminals, which should be approximately 18Vdc.
Channel [n]	Error	VRM	Alarm	The Vapor Recovery Monitor does not understand the data transmission.	This may happen when a channel is programmed for a magnostriptive probe but has a vapor flow meter connected instead.
	Pressure Sensor Open Circuit	VRM	Alarm	The pressure sensor is not connected to the Vapor Recovery Monitor.	Usually due to a bad connection or a broken wire. In some cases the sensor may not be working. First check the connections inside the dispenser junction box then at the Console terminal block. Second, measure the voltage at the terminal blocks and verify the voltage. See page 17.
	External TS-DIM Connection Down	VRM	Alarm	No communication between the TS-DIM and the Console.	Occurs with bad connection, TS-DIM does not have power, TS-DIM is not working. Check the wiring between the TS-DIM and the Console. Check the jumper settings in the TS-DIM, see installation manual.
	TS-DIM Read Data Error	VRM	Alarm	Bad communication to the Console.	Most likely a baud rate problem. Check the baud rate in the Console as well as the jumper settings in the TS-DIM.
	External ATG Connection Down	VRM	Alarm	No communication or bad communication between the ATG and the Console.	Check the comm. Port settings in both the ATG and the Console. These comm. Port settings should match. Make sure there is a straight serial cable between the ATG and the Console.
Printer	Check Thermal Printer	System	Warning	Printer is out of paper, or the printer door is open.	Make sure the printer has paper, and the printer door is closed completely.
	Printer Head Temperature	System	Warning	Print head high temperature (65°C) persists for at least 2 minutes.	Printer will resume printing and the alarm will clear after a short cool-down period. Keep the console area cool and ventilated. If the alarm does not clear, contact FFS Technical Support.
	Printer Paper Jam	System	Warning	Indicates that paper is jammed in the printer	Carefully lift printer cover to inspect and remove jammed paper.

Device	Description	Category	Type	Definition	Possible Cause and Solution
Slot [n]	[i] Module is offline, where <i>i</i> is the module number	System	Alarm	Occurs when a module is not communicating with the controller.	If RED LED is on or Green LED is blinking try cycling power.
	[i] Module number mismatch, where <i>i</i> is the module number	System	Alarm	Occurs when the number of modules does not match the programmed number of modules.	Check the setup at System Configuration»Modules Expected to see if the correct numbers are programmed.
	System Bus Error	System	Alarm	The communication bus is not working properly.	Check to see if a particular module has a red Error LED. If so try to trouble shoot the bad module. Also try removing the bad module and see if the alarm goes away.
TS-DTUn	Remote DTU is Offline	System	Alarm	A remote DTU is not communicating to the console DTU.	Wrong ID Number Dispenser Powered Off Not installed correctly Not on same phase voltage as console DTU
	Console DTU number mismatch	System	Alarm	The console DTU is not communicating with the console.	Bad bus connection Not powered
	DTU FFS Interference	System	Alarm	Two networks have the same Network ID	Change Network ID



3760 Marsh Road • Madison, WI 53718, U.S.A.
Tel: +1 608 838 8786 • Fax: +1 608 838 6433
Tel: USA & Canada 1 800 225 9787 • Tel: México 001 800 738 7610

Franklin Fueling Systems GmbH
Rudolf-Diesel-Strasse 20 • 54516 Wittlich, GERMANY
Tel: +49-6571-105-380 • Fax: +49-6571-105-510

TS-VFM

Installation Guide

This install guide provides necessary installation instructions for the mounting of the INCON Vapor Flow Meter inside a dispenser or inside a dispenser sump. Information regarding the cabling and the connection to the Tank Sentinel Console is found in the *Tank Sentinel Installation Guide* (p/n 000-2150). All documentation relating to operability, maintenance, and testing of the Vapor Flow Meter is found in the *Vapor Recovery Monitor Operator's Guide* (p/n 000-2058).

Important: See the Vapor Recovery Install/Operators Manual or Tank Sentinel Installation Manual for Important Safety Messages.

Required Tools

- Pipe joint tape (Oil and gasoline compatible PTFE Tape)
- Pipe Wrench
- Small screwdriver (terminal block connection)
- Slip joint pliers (crimping splice connector)

Related Documents

- 000-2058 : *Vapor Recovery Monitor Operators Guide*
- 000-2150 : *Tank Sentinel Installation Guide - TS-5XXX Series*
- 000-2142 : *Tank Sentinel Programming Guide - TS-5XXX Series*
- 000-2151 : *Tank Sentinel Operator's Guide - TS-5XXX Series*

Preparation

Only use approved pipe joint tape (Oil and gasoline compatible PTFE Tape) for joints connecting to the Vapor Flow Meter. The use of non hardening, "pipe-dope," thread sealant is strictly prohibited and will void the warranty.

1. Perform a site inspection. Determine how the Vapor Flow Meter will be installed. The preferred installation method for this product is to install above the vapor shear valve. If there is not enough room between the vapor shear valve and the vapor pump, installation below the shear valve may be needed.
2. If the Vapor Recovery equipment is going to be installed on an existing service station, verify that there is a run of intrinsically safe conduit going back to the console. Vapor Flow Meter wiring can share the same space with other intrinsically safe cables, but cannot be run with non-intrinsically safe cables.
3. Make sure that all contractor-supplied piping materials are compatible with California fuels and meet all local codes.

Parts List and Materials Needed

Table 1 - Above Shear Valve

Item Description	Supplied By	Quantity
Vapor Flow Meter, TS-VFM	INCON	1
Sensor Installation Kit, 020-1509	INCON	1
Weatherproof Junction Box	Contractor	1
1.5" to 1" reducing bushing	Contractor	1
1.5" to ___" reducing bushing*	Contractor	1
1" pipe nipple	Contractor	1
___" pipe nipple*	Contractor	1
Pipe Union	Contractor	1

Table 2 - Below Shear Valve

Item Description	Supplied By	Quantity
Vapor Flow Meter, TS-VFM	INCON	1
Sensor Installation Kit, 020-1509	INCON	1
Weatherproof Junction Box	Contractor	1
1.5" pipe nipple	Contractor	2
1.5" pipe union	Contractor	1

* - piping size is dependent on vapor piping size inside the dispenser. Typically the connection to a Healy VP1000 is a ½" NPT. Thus, the bushing size will be 1.5" to 0.5".

Installation Steps

Above Shear Valve

1. Lock and tag out power to the dispenser and the console before attempting any work on the dispenser.
2. Refer to Figure 1 for reference.
3. Do not remove the protective caps on the Vapor Flow Meter until you are ready to thread the nipples into the Flow Meter.
4. Begin by connecting the two 1.5" to 1" reducing bushings to the Vapor Flow Meter's body. Be sure to use only Oil and gasoline compatible PTFE tape when sealing these threads. Take special precaution not to let any foreign material fall inside of the Vapor Flow Meter.
5. Next, start assembling the hardware from the bottom up. Connect a short, 1" NPT threaded nipple to the top of the vapor shear valve and to the 1.5" to 1" reducing bushing on the flow meter.
6. Connect another 1" pipe nipple to the top reducing bushing followed by a 1" pipe union. The existing dispenser piping can now connect to the top of the union.
7. If there is not already a watertight junction box for the intrinsically safe cables, then install one as described earlier in Tools Required.
8. Pull the black Vapor Flow Meter cable through the supplied cable grip and into the junction box. Using the supplied crimp connectors, splice the flow meter cable to the field cable. The color codes on the black flow meter cable are: **Red = +** (plus) and **Black = -** (minus)

Below Shear Valve

1. Lock and tag out power to the dispenser and the console before attempting any work on the dispenser.
2. Refer to Figure 2 for reference.
3. Do not remove the protective caps on the Vapor Flow Meter until you are ready to thread the nipples into the Flow Meter.
4. Begin by connecting two 1.5" NPT pipe nipples to the Vapor Flow Meter's body. Be sure to use only Oil and gasoline compatible PTFE tape when sealing these threads. Take special precaution not to let any foreign material fall inside of the Vapor Flow Meter.
5. Next, prepare the piping inside of the dispenser sump to connect to the Vapor Flow Meter. If flexible piping is currently installed, make sure, when adding the Vapor Flow Meter, that there are no bend radii that are too sharp, kinks, or traps. The contractor may need to replace the existing flexible piping with a shorter length in order to avoid potential flow restrictions.
6. Add the Vapor Flow Meter between the existing piping in the sump and the bottom of the vapor shear valve. In most cases the vapor shear valve will need to be temporarily removed in order to assist with making the connection. Add a union to either the top of the shear valve or below the shear valve.
7. If there is not already a watertight junction box for the intrinsic safe cables, then install one as described earlier in Tools Required.
8. Pull the black Vapor Flow Meter cable through the supplied cable grip and into the junction box. Using the supplied crimp connectors, splice the flow meter cable to the field cable. The color codes on the black flow meter cable are: **Red = +** (plus) and **Black = -** (minus)

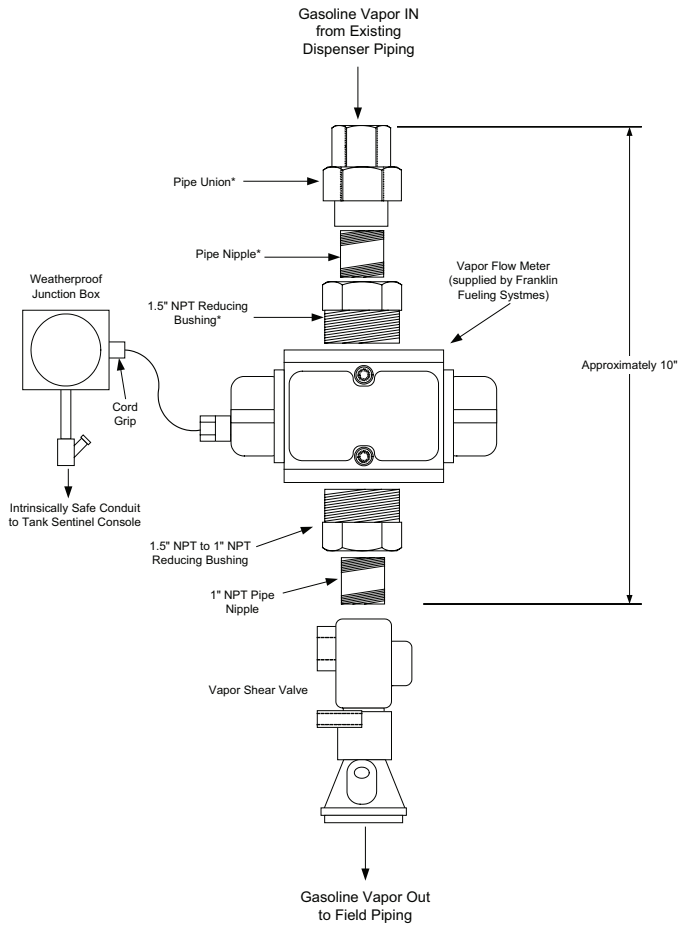

Figure 1
Flow Meter Above Shear Valve

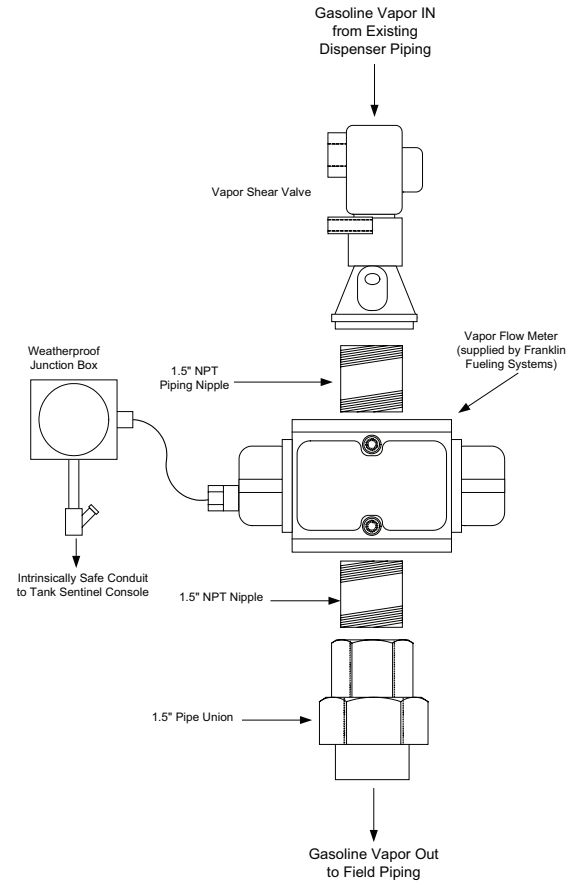
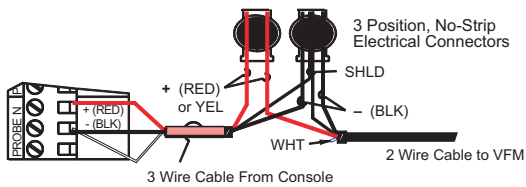
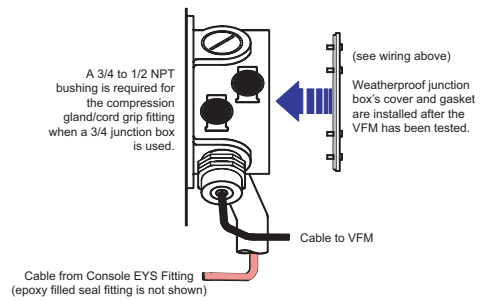

Figure 2
Flow Meter Below Shear Valve



To splice: Insert stripped wires and use a slip-joint pliers to seat the black piece.



Franklin Fueling Systems

www.franklinfueling.com

3760 Marsh Road • Madison, WI 53718, U.S.A.

Tel: +1 608 838 8786 • Fax: +1 608 838 6433

Tel: USA & Canada 1 800 225 9787 • Tel: México 001 800 738 7610

Franklin Fueling Systems GmbH

Rudolf-Diesel-Strasse 20 • 54516 Wittlich, GERMANY

Tel: +49-6571-105-380 • Fax: +49-6571-105-510



TS-VPS

Installation Guide

This install guide provides necessary installation instructions for the mounting of the INCON Vapor Pressure Sensor inside a dispenser, inside a dispenser sump, or on the top of a tank riser. Information regarding the cabling and the connection to the Tank Sentinel Console is found in the *Tank Sentinel Installation Guide*, (p/n 000-2150). All documentation relating to operability, maintenance, and testing of the Vapor Pressure Sensor is found in the *Vapor Recovery Monitor Operator's Guide* (p/n 000-2058).

Important: See the Vapor Recovery Install/Operators Manual or Tank Sentinel Installation Manual for Important Safety Messages.

Required Tools

- Pipe joint tape (Oil and gasoline compatible PTFE Tape)
- Adjustable Wrench
- Small screwdriver (terminal block connection)
- Slip joint pliers (crimping splice connector)

Related Documents

- 000-2058 : *Vapor Recovery Monitor Operators Guide*
- 000-2150 : *Tank Sentinel Installation Guide - TS-5XXX Series*
- 000-2142 : *Tank Sentinel Programming Guide - TS-5XXX Series*
- 000-2151 : *Tank Sentinel Operator's Guide - TS-5XXX Series*

Preparation

1. Perform a site inspection. Determine how the Vapor Pressure Sensor will be installed. The preferred installation method for this product is to come off the horizontal 1" port of the vapor shear valve. If this is not possible, then a piping tee may need to be installed below the Vapor Flow Meter.
2. If the Vapor Recovery equipment is going to be installed on an existing service station, verify that there is a run of intrinsically safe conduit going back to the console. Vapor Flow Meter wiring can share the same space with other intrinsically safe cables, but cannot be run with non-intrinsically safe cables.
3. Make sure that all contractor-supplied piping materials are compatible with California fuels and meet all local codes.

Parts List and Materials Needed

Table 1 - Off Shear Valve

Item Description	Supplied By	Quantity
Vapor Pressure Sensor, TS-VPS	INCON	1
Sensor Installation Kit, 020-1509	INCON	1
Weatherproof Junction Box	Contractor	1
1" to 0.5" reducing bushing	Contractor	1

Table 2 - Below Shear Valve

Item Description	Supplied By	Quantity
Vapor Pressure Sensor, TS-VPS	INCON	1
Sensor Installation Kit, 020-1509	INCON	1
Weatherproof Junction Box	Contractor	1
1" to 0.5" reducing bushing	Contractor	1
1.5" Piping Tee	Contractor	1

Installation Steps

Installation Steps Off the Vapor Shear Valve

1. Lock and tag out power to the dispenser and the console before attempting any work on the dispenser.
2. Refer to Figure 1 for reference.
3. Begin by removing the 1" plug from the vapor shear valve and installing a 1" to ½" reducing bushing.
4. If there is not already a watertight junction box for the intrinsically safe cables, then install one as described earlier in Tools Required.
5. Pull the black Vapor Pressure Sensor cable through the supplied cable grip and into the junction box. Using the supplied crimp connectors, splice the flow meter cable to the field cable. The color codes on the black Vapor Pressure Sensor are: Black = + (plus) and White = - (minus).

Installation Steps Below the Vapor Shear Valve

1. Lock and tag out power to the dispenser and the console before attempting any work on the dispenser.
2. Refer to Figure 1 for reference.
3. Install a 1.5" piping tee below the Vapor Shear Valve.
4. Install an appropriate bushing sized to get to the supplied ½" piping nipple.
5. If there is not already a watertight junction box for the intrinsically safe cables, then install one as described earlier in Tools Required.
6. Pull the black Vapor Pressure Sensor cable through the supplied cable grip and into the junction box. Using the supplied crimp connectors, splice the flow meter cable to the field cable. The color codes on the black Vapor Pressure Sensor are: Black = + (plus) and White = - (minus).

Figure 1

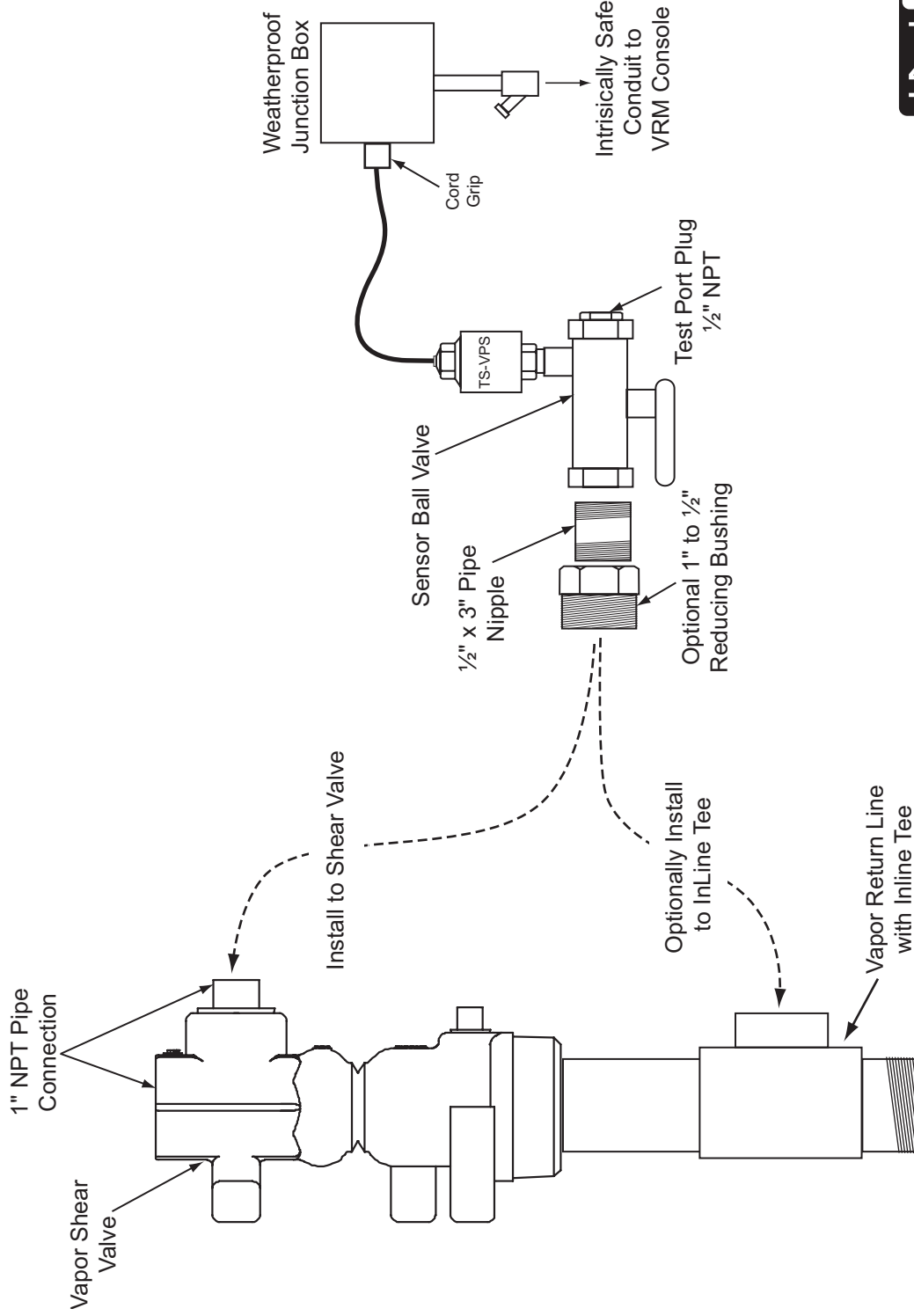

INCON[®]

Franklin Fueling Systems

www.franklinfueling.com

3760 Marsh Road • Madison, WI 53718, U.S.A.

Tel: +1 608 838 8786 • Fax: +1 608 838 6433

Tel: USA & Canada 1 800 225 9787 • Tel: México 001 800 738 7610

Franklin Fueling Systems GmbH

Rudolf-Diesel-Strasse 20 • 54516 Wittlich, GERMANY

Tel: +49-6571-105-380 • Fax: +49-6571-105-510



Franklin Fueling Systems

INCON[®]

Data Transfer Unit

Dispenser Retrofit Manual

Model TS-DTU

Important Safety Messages

Franklin Fueling Systems (FFS)/Healy equipment is designed to be installed in association with volatile hydrocarbon liquids such as gasoline and diesel fuel. Installing or working on this equipment means working in an environment in which these highly flammable liquids may be present. Working in such a hazardous environment presents a risk of severe injury or death if these instructions and standard industry practices are not followed. Read and follow all instructions thoroughly before installing or working on this, or any other related, equipment.

As you read this guide, please be aware of the following symbols and their meanings:

Warning  This symbol identifies a warning. A warning sign will appear in the text of this document when a potentially hazardous situation may arise if the instructions that follow are not adhered to closely. A potentially hazardous situation may involve the possibility of severe bodily harm or even death.

Caution  This is a caution symbol. A caution sign will appear in the text of this document when a potentially hazardous environmental situation may arise if the instructions that follow are not adhered to closely. A potentially hazardous environmental situation may involve the leakage of fuel from equipment that could severely harm the environment.

Warning  **Follow all applicable codes governing the installation and servicing of this product and the entire system. Always lock out and tag electrical circuit breakers while installing or servicing this equipment and any related equipment. A potentially lethal electrical shock hazard and the possibility of an explosion or fire from a spark can result if the electrical circuit breakers are accidentally turned on during installation or servicing. Please refer to the Installation and Owner's Manual for this equipment, and the appropriate documentation for any other related equipment, for complete installation and safety information.**

Warning  **Follow all federal, state and local laws governing the installation of this product and its associated systems. When no other regulations apply, follow NFPA codes 30A and 70 from the National Fire Protection Association. Failure to follow these codes could result in severe injury, death, serious property damage and/or environmental contamination.**

Warning  **Always secure the work area from moving vehicles. The equipment in this manual is usually mounted underground, so reduced visibility puts service personnel working on this equipment in danger from moving vehicles entering the work area. To help eliminate these unsafe conditions, secure the area by using a service truck to block access to the work environment, or by using any other reasonable means available to ensure the safety of service personnel.**

Warning  **Use circuit breakers for multiple disconnect to turn off power and prevent feedback from other dispensers.**

Important: All electrical and hydraulic plumbing fittings referred to in these instructions must be UL "listed" or "recognized" for the purpose.

Important: The TS-DTU will increase the current draw of the dispenser by 0.25 amps. Use the label supplied to note this change.

Contents

Important Safety Messages	2
Purpose:	4
Specifications:.....	5
Tools Required	6
Installing the TS-DTU in the Dispenser	6
Mounting the TS-DTU module	6
Intrinsically Safe Wiring.....	6
Connecting the Vapor Flow Meter and Vapor Pressure Sensor.....	7
TS-VFM Splice	7
TS-VPS Splice.....	7
Dispenser Specific Installation	7
Gilbarco Advantage Narrow Frame	8
Gilbarco Encore 300 and 500 Series.....	12
Tokheim Premier B	16
Tokheim Premier C	20
Wayne Vista 1	28
Wayne Vista 2.....	32
Wayne Vista 3.....	36

Purpose:

This procedure describes the tools, methods and skill levels required to install an INCON/Franklin Fueling Systems model TS-DTU, Data Transfer Unit in UL Approved Dispensers. Each installation of a TS-DTU in a dispenser requires that a TS-DRK, dispenser installation kit, be used. The TS-DRK is ordered by specific dispenser types. Refer to Table 1 for the correct TS-DRK model. Only INCON/Franklin Fueling Systems trained and certified contractors will be able to perform these retrofits or warranty will be void. The installer shall be a skilled petroleum technician and thoroughly familiar with the requirements of State, Federal and local codes for installation and repair of gasoline dispensing equipment. Also, they shall be aware of all the necessary safety precautions and site safety requirements to assure a safe and trouble free installation. NOTE: All electrical fittings referred to in these instructions must be UL "listed" or "recognized" for the purpose.

Important Safety Messages

Before installing the equipment, read, understand and follow:

- The National Electrical Code (NFPA 70)
- The Automotive and Marine Service Code (NFPA 30A)
- Any national, state and local codes that may apply.

The failure to install the equipment in accordance with NFPA 30A and 70 may adversely affect the safe use and operation of the system. Accurate, sound installations reduce service calls: Use experienced, licensed contractors that practice accurate, safe installation techniques. Careful installation provides a sound troubleshooting framework for field repairs and can eliminate potential problems.

1. Read all instructions before beginning.
2. Follow all safety precautions:
 - Barricade the area.
 - Do not allow vehicles or unauthorized people in the area.
 - Do not smoke or allow open flames in the area.
 - Do not use power tools in the work area.
 - Wear eye protection during installation.
3. Use circuit breaker for multiple disconnects to turn off power and prevent feedback from other dispensers.

Specifications:

Power 100-240 VAC, 60 Hz, 0.25 A

Parts List

The TS-DTU and TS-DRK installation kit consists of the following major components. Make sure you have these parts before installing the DTU.



Figure 1: TS-DTU/P Data Transfer Unit

- TS-DTU
- Mounting Plate
- Fasteners (5 screws, nuts, and washers)



Figure 2: 020-1513 IS Conduit Kit

- Straight Conduit Fitting
- 90degree Conduit Fitting
- Conduit Reducer
- Flexible Conduit (1/2" PVC)
- Two splice connectors



Figure 3: 131610 Potted Nipple Assembly

One harness included per instal kit. Refer to table 1 for list of install kits.

<p>Power Harness 600-0166 when using Wayne Dispenser</p>	
<p>Power Harness 600-0167 when using Gilbarco Encore Dispenser</p>	
<p>Power Harness 600-0168 when using Gilbarco Advantage Dispenser</p>	
<p>Power Harness 600-0165 when using Tokheim Dispenser</p>	

Figure 4: Power Harness Kits

General Instructions

Tools Required

(This applies to all dispenser installation procedures)

Assorted Open End Wrenches 1/4" through 3/4"

Wire Cutters/Strippers 16 AWG to 26 AWG

3/8" Drill Assembly

Assorted Drill Bits 1/16" through 7/16"

Assorted Screwdrivers (Flat blade-one must be 1/8" wide)

3/4" Conduit Hole Punch (For potted nipple assembly)

Electrical Multi-meter

12" adjustable Wrench

18" Channel lock Pliers

Attaching the Mounting Bracket

For each dispenser installation, the mounting bracket will need to be attached to the back side of the TS-DTU. Refer to each dispenser installation instruction as it will specify the correct orientation of the bracket

1. Remove the TS-DTU enclosure cover and set it aside.
2. Find the correct orientation for the mounting bracket in the dispenser-specific instructions.
3. Find two screws, washers, and star nuts from the TS-DTU/P kit. Insert the two screws into the two mounting holes of the front face of the TS-DTU enclosure.
4. Put the mounting bracket on the side of the DTU enclosure and install a washer and star nut.

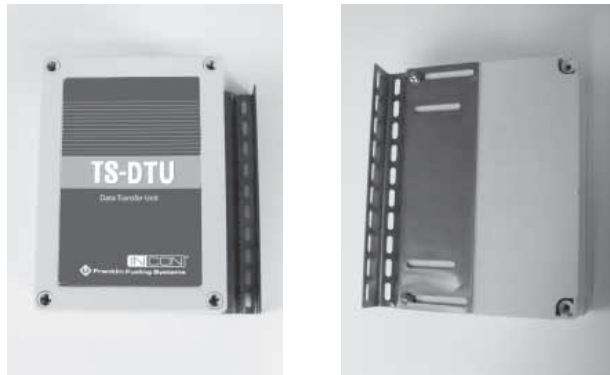

Figure 5: Mounting Bracket On Side Of Unit

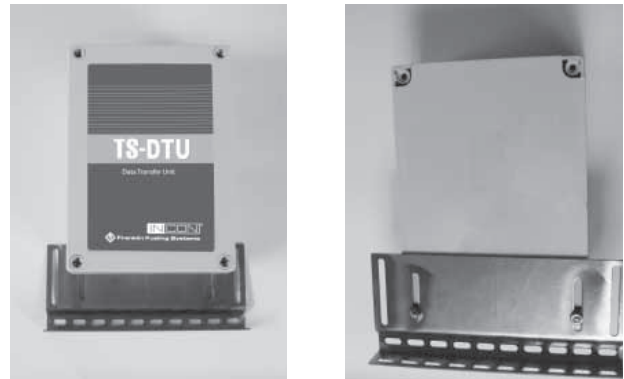

Figure 6: Mounting Bracket On Bottom Of Unit

Intrinsically Safe Wiring

The Intrinsically safe wiring is the same for all type of dispensers. The wires from the top end of a potted nipple should be connected to the TS-DTU module and from the bottom end to the TS-VFM and TS-VPS. These wires connect intrinsically safe devices (TS-VFM and TS-VPS) to the associated apparatus (TS-DTU) and therefore must be protected in non-hazardous area where TS-DTU is located.

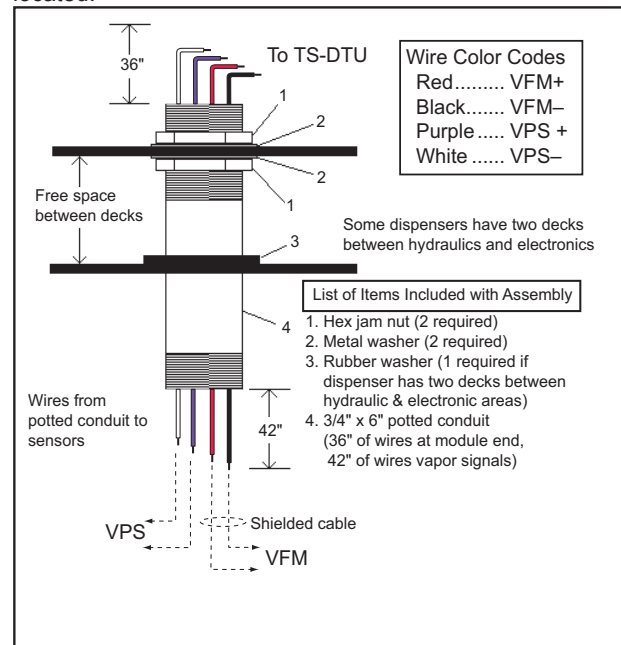

Figure 7: Potted Nipple Assembly

Follow the dispenser-specific instructions for the installation location and procedure of the potted nipple on the dispenser vapor barrier.

Connecting the Vapor Flow Meter and Vapor Pressure Sensor

The connection of potted nipple to the TS-VFM and TS-VPS in the lower section of the dispenser is the same for all dispensers. For ease of installation, a junction box may be connected directly to the bottom of the potted nipple. Note, the potted nipple is a 3/4" conduit thread, see Figure 8.



Figure 8: Junction Box Connected to Potted Nipple

TS-VFM Splice

1. Find two-splice connectors in the IS Wiring Kit, 020-1513.
2. Make the following splice connections:
 - Red wire of potted nipple to Red wire of TS-VFM cable.
 - Black wire of potted nipple to Black wire of TS-VFM cable.



Figure 9: VFM and VPS Spices

TS-VPS Splice

1. Find two wire nuts in the Power Harness Kit, 600-016X.
2. Make the following splice connections:
 - Purple wire of potted nipple to Black wire of TS-VPS cable.
 - White wire of potted nipple to White wire of TS-VPS cable (Refer to Figure 9).

Dispenser Specific Installation

This manual covers the following types of dispensers:

Make	Type	Installation Kit
Gilbarco	Advantage	TS-DRK/A
	Encore 300 & 500	TS-DRK/E
Tokheim	Premier B	TS-DRK/T
Tokheim	Premier C	TS-DRK/T
Wayne	Ovation	TS-DRK/W
	Vista 1V, 2V, 3V	TS-DRK/W

Table 1: Dispenser Kits

Gilbarco Advantage Narrow Frame

This section illustrates the basic components needed to retrofit a TS-DTU module into an existing or UL remanufactured dispenser. This system can be installed in any "Non-Vapor or Vapor Ready" dispenser including dispensers with existing "Balance" or "VacAssist" piping.

1. Loosen three bolts at the bottom of each main door assembly.



Figure 1: Loosen Bolts

2. Unlock the left options door on each main door.



Figure 2: Open Options Door

3. Lift latch on right side of left options door opening to release right options door on each side of the dispenser.



Figure 3: Release Options Door

4. Disengage two latches, one in each right and left options door openings, and open main door on both sides of dispenser.
5. Move to side A of dispenser. Side A can be determined by the side that the credit card reader (crind) tray pops out.
6. Find ground wire mounting location shown and remove screw and star washer.



Figure 4: Find Ground Wire

7. Reinstall ground with ring terminal screw and star washer in alternate location shown. Tighten screw securely.

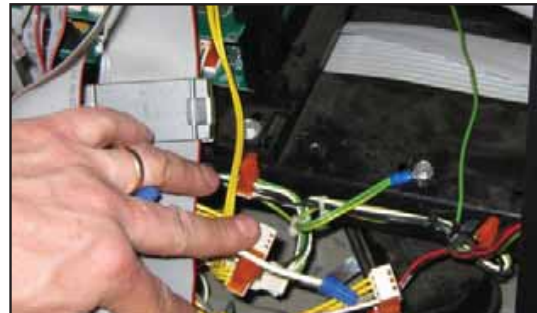

Figure 5: Reinstalled Ground Wire

8. Find shield covering opening in air gap and remove two bolts from shield. Retain shield and bolts for future reassembly.



Figure 6: Air Gap Shield

Gilbarco Advantage Narrow Frame - DTU Installation

9. Remove two screws from upper air gap knock-out cover and remove. Discard cover but keep screws for reuse.



Figure 7: Remove Screws

10. Remove two screws from lower air gap knockout cover and remove. Discard cover and screws.
11. Remove lower door from side A of dispenser using key lock on right side of door. Save door for future reassembly
12. Find potted nipple assembly, 131610. Remove all washers and nuts and set aside.
13. Pull wires from top side of potted nipple assembly through dispenser hydraulics enclosure up through opening in lower air gap knock-out.

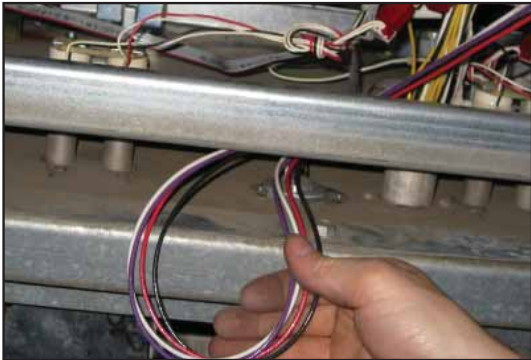

Figure 8: Potted Conduit wires

14. Attach one nut and washer onto the potted nipple assembly before pushing wires up through electrical enclosure.
15. Pull wires and then nipple assembly up into electronics enclosure. Fit washer and nut over wires and tighten nut securely in place, as shown in Figure 9.

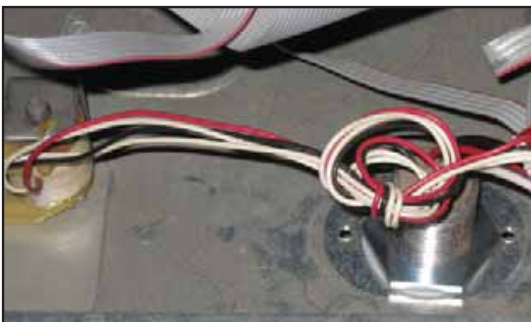

Figure 9: Potted Nipple Installed

16. Reattach air gap shield using screws previously retained in step 8.

17. Reinstall the screws previously retain in step 9. These screws seal the holes left behind by the air gap knockout.
18. Find TS-DTU/P kit and remove brackets, DTU, and hardware from box.
19. Remove cover from DTU.
20. Install mounting bracket to DTU with two screws, nuts and washers from hardware provided with DTU as described in the General Information section. Ensure that bracket is installed on correct side as shown.



Figure 10: Mounting Bracket on DTU

21. Remove two screws from IS wiring cover inside the DTU and remove cover. Retain cover and screws for reassembly
22. Find the 90 degree fitting from IS wiring kit, 020-1513. Remove nut from 90 degree fitting. Attach fitting to opening nearest IS wiring terminal block of DTU using nut previously removed.
23. Find power harness kit part number 600-0168. Find the Gilbarco Advantage power harness and ground with ring terminal as shown in figure 4 of the Parts List.
24. Put wiring harness end with crimp connector through opening in DTU nearest terminal block J1. Attach white lead to terminal block position labeled NEUTRAL and black lead to terminal block position labeled L1 on terminal block J1 of DTU. Attach ground wire to terminal block position labeled GND of J2 on DTU.



Figure 11: DTU Power Connections

25. Move DTU assembly to dispenser nearest intended mounting location

26. Find reducer from IS wiring kit, 020-1513. From electrical enclosure, pull wires from potted nipple assembly through 3/4" opening of reducer and attach reducer to the top of the nipple assembly.
27. Find straight conduit fitting from IS wiring kit, 020-1513. From electrical enclosure, pull wires from the potted nipple assembly through opening of straight conduit fitting. Attach straight conduit fitting onto the reducer.
28. Remove nut and bushing from straight conduit fitting. Place bushing on one end of flexible conduit. Push wires from nipple assembly through bushing/flexible conduit and secure flexible conduit to straight conduit fitting using nut.



Figure 12: Attaching Flexible Conduit

29. Remove nut and bushing from 90 degree conduit fitting and push flexible conduit through nut. Put bushing on unattached end of flexible conduit. Push wires from flexible conduit through the 90 degree conduit fitting and pull excess wire into DTU. Attach flexible conduit to 90-degree fitting with nut.



Figure 13: Attach Flexible Conduit to DTU

30. Cut excess wire inside DTU allowing a length of 2" for terminal block wiring. Strip insulation 3/8" from ends of wire. Attach wires to DTU terminal block as follows (DIAGRAM)

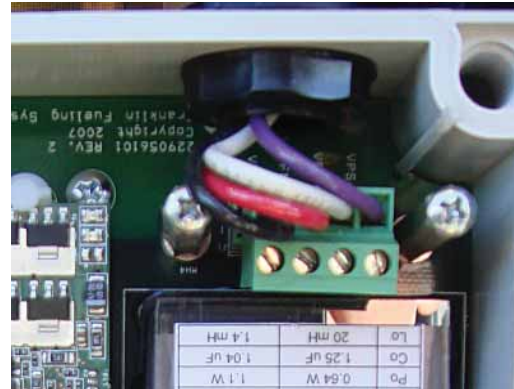

Figure 14: Attach Wiring to DTU

31. Reinstall barrier cover using screws that were removed in step 23.
32. Replace DTU cover.
33. Install the DTU assembly on the horizontal cross bracket as shown in Figure 15. Use the two screws, washers, and nuts as supplied in the TS-DTU/P hardware kit.



Figure 15: Attach DTU Mounting Bracket

34. Find input connector on AC distribution wiring harness and disconnect.
35. Insert new power harness with ferrites between input power and AC distribution harness.

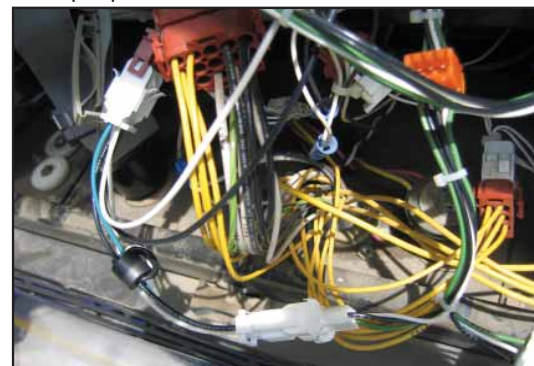

Figure 16: Connecting to Dispenser Power

Gilbarco Advantage Narrow Frame - DTU Installation

36. Attach ring terminal of DTU ground wire to dispenser with bolt, nut and star washer.



Figure 17: Attach Ground Wire

37. Use wire-wrap ties to attach excess wires from AC wiring harness together.
38. Use wire-wrap ties to attach excess wire from DTU power harness and ground away from door and gears.
39. Find cable assembly extending from TS-VFM vapor meter in dispenser hydraulics enclosure.
40. Find wiring from previously installed potted nipple assembly inside hydraulics enclosure.
41. Find two wire-splice connector kits. Inside hydraulics enclosure, connect black wire from potted nipple assembly to black wire from TS-VFM flow meter by placing each lead into an opening in the wire splice connector and push fitting closed to lock.
42. Find cable extending from TS-VPS inside hydraulics enclosure. Cut yellow and blue leads from end of cable.
43. Find purple and white wires from potted nipple assembly in hydraulics enclosure. Strip wiring insulation $\frac{3}{8}$ " from end of wire.
44. Using wire nuts provided with kit, attach purple wire from potted nipple assembly to black wire of TS-VPS and white wire from potted nipple assembly to white wire of the TS-VPS.
45. Close main doors on Side A and Side B.
46. Engage main door latches located in both option openings for each side. Refer to figure 2 & 3.
47. Tighten the three bolts at the bottom of each main door assembly. See figure 1.
48. Reinstall side A lower dispenser door. Firmly attach using key lock on right side of door.

Gilbarco Encore 300 and 500 Series

This section illustrates the basic components needed to retrofit a TS-DTU module into an existing dispenser. This system can be installed in any "Non-Vapor or Vapor Ready" dispenser including dispensers with existing "Balance" or "VacAssist" piping.

1. Unlock interface doors on both sides of dispenser. Open two latches on left side of interface door and open main doors.

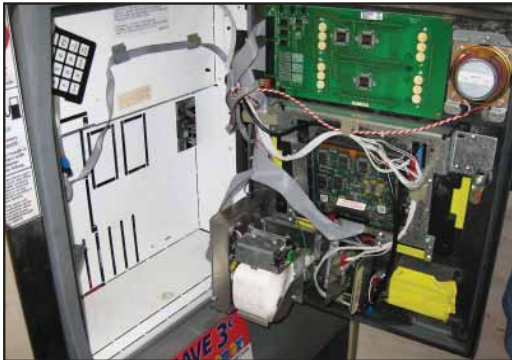

Figure 1: Open Doors

2. Find TS-DTU/P from kit and remove brackets, DTU, and hardware from box.
3. Remove cover from DTU.
4. Install mounting bracket to DTU using two screws, nuts and washers from hardware provided with DTU as described in the General Information section. Make sure the bracket is installed on correct side as shown.



Figure 2: Install Mounting Bracket

5. Install the DTU assembly on the horizontal cross bracket as shown in Figure 3. Use the two screws, washers, and nuts as supplied in the TS-DTU/P hardware kit.

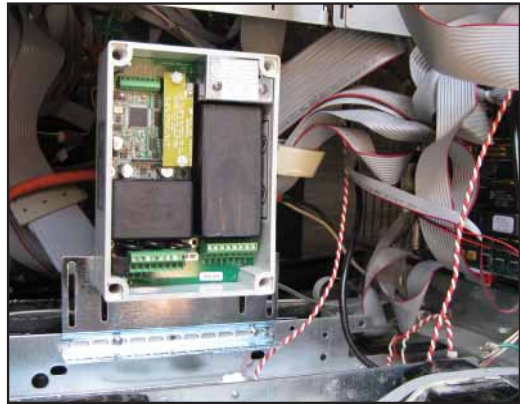

Figure 3: Mount DTU in Dispenser

6. Find power harness kit part number, 600-0167. Find the Gilbarco power harness as shown in figure 4 of the Parts List. Remove tie-wraps and uncoil. The Gilbarco cable will have green ground wire.
7. Inside dispenser, find the incoming power connection. Attach the new power extension cable between the original dispenser power connectors. Notice that the wire colors match up with the original connection.



Figure 4: Power Distribution Wires

8. Carefully route DTU power wiring harness to DTU.

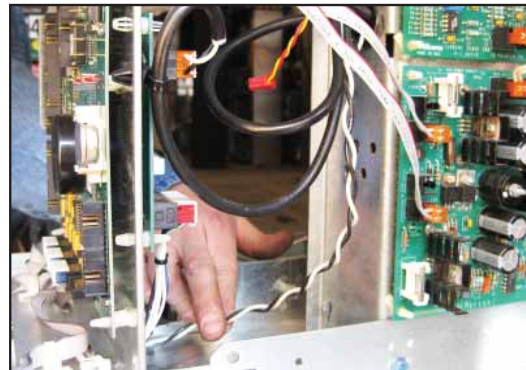

Figure 5: Power Wiring

9. Route crimp terminal end of harness through opening in the bottom of the DTU and connect white lead to terminal block position labeled NEUTRAL and black lead to terminal block position labeled L1 on terminal block J1 of DTU.

Gilbarco Encore 300 and 500 - DTU Installation



Figure 6: Connect Power Leads

10. Find ground wire from power harness kit 600-0165. Remove ties and uncoil. From end without ring coil, strip insulation 3/8" from end of wire.
11. Route ground wire end with out ring terminal through DTU and secure to terminal block.
12. Attach ring terminal of ground wire to dispenser bracket using screw and nut as shown. Coil excess wiring and tie it to ensure that it does not interfere with door closing.

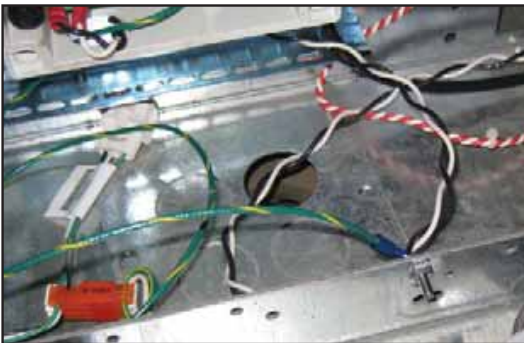

Figure 7: Attach Ground Wire

13. Find side of dispenser opposite of power supply. Remove lower door on that side of dispenser by loosening two screws.
14. Remove lower doors on both sides of dispensers. Set doors aside and save for later assembly
15. Find knockout panel on the bottom of the electrical enclosure closest to the DTU (See Figure 7).
16. Using screwdriver, remove one knockout plug from knockout panel.
17. Find potted nipple assembly, 131610. Undo wire ties and uncoil wiring.
18. Remove top nut from potted nipple and remove one washer by pulling over wire leads. Keep nut and washer for future use.
19. Pull wires from top of potted nipple assembly up through the opening created in step 16 from the hydraulics enclosure to the electrical enclosure. Ensure that wiring is not damaged by sharp edges.



Figure 8: Pulling Wires Through Opening

20. Pull top of potted nipple assembly through the bottom of the electrical enclosure as shown in Figure 9.

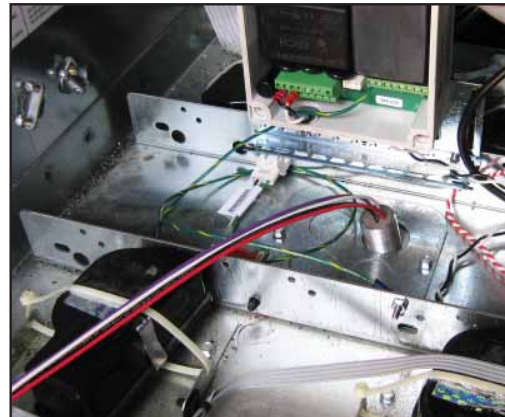

Figure 9: Potted Nipple in Position

21. Put wires in electrical enclosure through washer and nut that were removed from potted nipple assembly in step 18.
22. Tighten nut to tightly hold potted nipple assembly.
23. Find reducer from IS wiring kit, 020-1513. From electrical enclosure, pull wires from the potted nipple assembly through 3/4" opening of reducer and attach reducer to the top of the nipple assembly.

24. Find straight conduit fitting from IS wiring kit 020-1513. From electrical enclosure, pull wires from the potted nipple assembly through opening of straight conduit fitting. Attach straight conduit fitting onto the reducer. Refer to Figure 10.



Figure 10: Reducer Installed

25. Remove two screws from IS wiring cover inside the DTU and remove cover. Keep cover and screws for future reassembly.
26. Find the 90-degree fitting from IS wiring kit, 020-1513. Remove nut from 90-degree fitting. Attach fitting to opening of DTU nearest the IS connector using nut previously removed.



Figure 11: 90-degree Fitting Installed

27. Find the flexible conduit from the IS Wiring Kit, 020-1513. Using 90-degree fitting and straight fitting installed earlier, determine length of flexible conduit assembly needed and cut to fit. Refer to Figure 12.

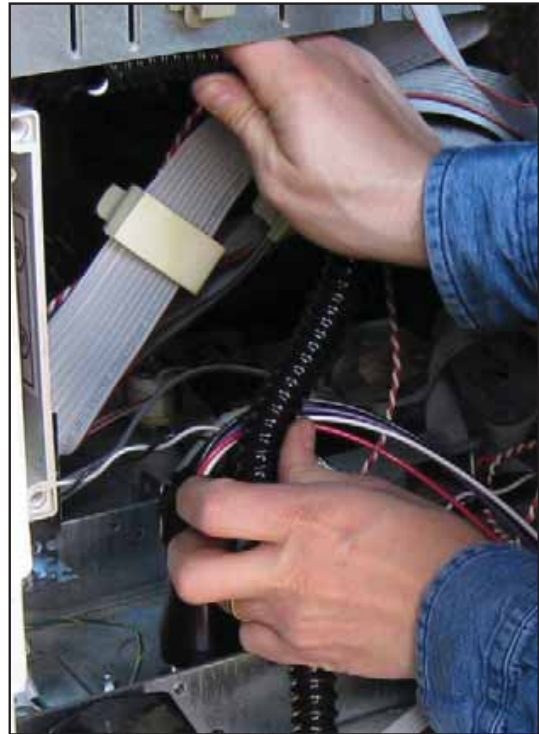

Figure 12: Flexible Conduit Installation

28. Pull wires from potted nipple assembly through flexible conduit.
29. Remove nut and bushing from straight conduit fitting.
30. Push bushing onto end of flexible conduit and reattach to straight fitting using nut.
31. Remove bushing and nut from 90-degree conduit fitting on DTU and pull wiring/flexible conduit through.
32. Route wires through 90-degree conduit fitting and pull into the DTU enclosure.



Figure 13: Wires in Flexible Conduit

33. Using nut and then bushing, attach flexible conduit to 90-degree conduit fitting.

34. Cut excess wire inside DTU allowing a length of 2" for terminal block wiring. Strip wire insulation 3/8" from the end. Connect wires to DTU terminal block.



Figure 14: Wiring Connection to DTU

35. Reinstall barrier cover using screws from step 23.

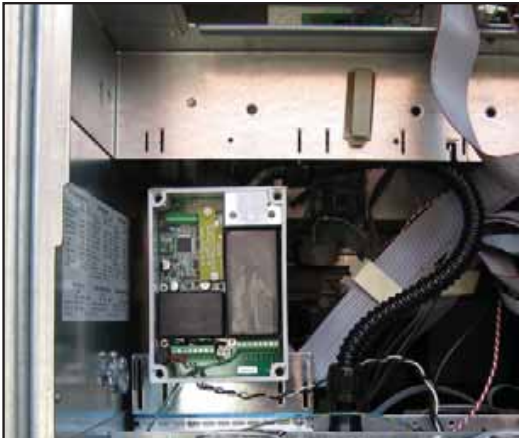

Figure 15: Reinstall Barrier

36. Replace DTU cover.



Figure 16: Replace Cover

37. Find cable assembly extending from TS-VFM vapor meter in dispenser hydraulics enclosure.
38. Find wiring from previously installed potted nipple assembly inside hydraulics enclosure.
39. Find two wire splice connector kits. Inside hydraulics enclosure connect black wire from potted nipple assembly to black wire from TS-VFM flow meter by putting each lead into an opening in the wire splice connector and push fitting closed to lock.
40. Find cable extending from TS-VPS inside hydraulics enclosure. Cut yellow and blue leads from end of cable.
41. Find purple and white wires from potted nipple assembly in hydraulics enclosure. Strip wiring insulation 3/8" from end of wire.
42. Using wire nuts provided with kit, attach purple wire from potted nipple assembly to black wire of TS-VPS and white wire from potted nipple assembly to white wire of the TS-VPS.
43. Attach lower hydraulics covers to dispenser and secure each using key lock.
44. Close both main doors of dispenser. Securely attach the two latches on the left side of each interface door.
45. Close both interface doors and lock.

Tokheim Premier B (422B)

This section illustrates the basic components needed to retrofit a TS-DTU module into an existing dispenser. This system can be installed in any "Non-Vapor or Vapor Ready" dispenser including dispensers with existing "Balance" or "VacAssist" piping.

Note: Conduit knockouts measure 1 1/4". Holes are too small for conduits to make a good seal. These knockouts cannot be used. New conduit knockouts will need to be made.

1. Open right options door with key on Side A of dispenser. Side A has manufacturer's nameplate. Remove door and set aside for future installation.



Figure 1: Unlocking door

2. Open printer door on B side of dispenser.



Figure 2: Unlock Printer Door

3. Unlock right options door on B side of dispenser.



Figure 3: Release Latch

4. Release latch on display cover on B side of

dispenser.



Figure 4: Lower Display Assembly

5. Loosen two screws on display assembly and lower it.
6. Remove lower hydraulics door from side A of dispenser by releasing key lock on either side of door.
7. From side A of dispensers, examine opening on right side of electrical enclosure. Choose drilling location ensuring that components in electrical enclosure and hydraulics enclosure will not be disturbed by the drilling. Use washer to insure proper clearance after install.



Figure 5: Mark Drilling Location

8. Using a low speed pneumatic drill, drill a small pilot hole through the bottom of the electrical enclosure.

Note: During drilling, put a catch pan under the drilling location to catch shavings and metal filing during drilling operation.

9. Carefully remove all metal filing and shavings from inside of electrical enclosure.

Tokheim Premier B DTU Installation

10. Using a 3/4" conduit hole punch, open hole previously drilled.

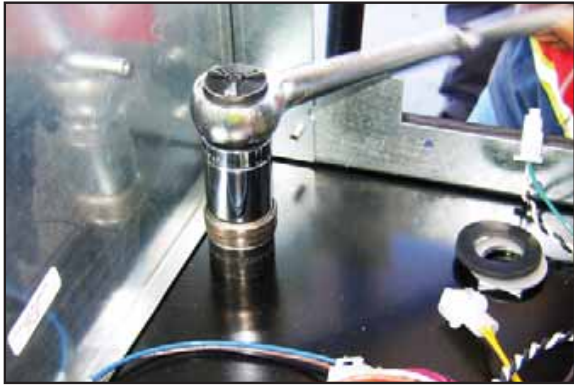

Figure 6: Use Hole Punch

11. Find potted nipple assembly, 131610. Undo wire ties and unwind wiring.
12. Remove and dispose of rubber washer from assembly.
13. Remove top nut and washer from potted nipple. Keep nut and washer for future use.
14. Pull wires from top of potted nipple assembly up from the hydraulics enclosure to the electrical enclosure. Make sure wiring is not damaged by sharp edges.
15. Pull top of potted nipple assembly through opening in electrical enclosure. Push wires inside electrical enclosure through washer and nut retained in step 13. Securely attach potted nipple assembly by tightening nut.



Figure 7: Potted Nipple Assembly Attached

16. Find reducer from IS wiring kit 020-1513. From electrical enclosure, pull wires from the potted nipple assembly through 3/4" opening of reducer and thread reducer to the top of the nipple assembly.
17. Find straight conduit fitting from IS wiring kit. From electrical enclosure, pull wires from the potted nipple assembly through opening of straight conduit fitting. Attach straight conduit fitting onto the reducer.
18. Find TS-DTU/P kit and remove brackets, DTU, and fasteners from box.
19. Remove cover from DTU.



Figure 8: DTU Open

20. Install mounting bracket to DTU with two screws, nuts and washers from hardware provided with DTU as described in the General Information section. Ensure that bracket is installed on correct side as shown.
21. Remove two screws from IS wiring cover inside the DTU and remove cover. Retain cover and screws for future reassembly
22. Find 90-degree fitting from IS wiring kit. Remove nut from 90-degree fitting. Attach fitting to opening nearest IS wiring terminal block of DTU using nut previously removed.



Figure 9: Attach 90-degree Fitting

23. Find power harness kit part number 600-0165. Find the Tokheim power harness and ground wire with ring terminal as shown in figure 4 of the Parts List. Remove tie-wraps and uncoil.
24. Route wiring harness end with crimp connector through opening in DTU nearest terminal block J1. Attach white lead to terminal block position labeled NEUTRAL and black lead to terminal block position labeled L1 on terminal block J1 of DTU. Attach ground wire to terminal block position labeled GND of J2 on DTU.

Tokheim Premier B DTU Installation

25. Remove nut and bushing from straight conduit fitting. Place bushing on one end of flexible conduit. Push wires from nipple assembly through bushing/flexible conduit and attach flexible conduit to straight conduit fitting using nut.



Figure 10: Attach Flexible Conduit to Potted Nipple

26. Remove nut and bushing from 90-degree conduit fitting and pull flexible conduit through nut. Attach bushing on unattached end of flexible conduit. Pull wires from flexible conduit through the 90-degree conduit fitting and pull excess wire into DTU.
27. Attach flexible conduit to 90-degree fitting with nut.



Figure 11: Attach Flexible Conduit to 90-Degree Fitting

28. Cut excess wire inside DTU allowing a length of 2" for terminal block wiring. Strip wire insulation 3/8" from the ends of wire. Attach wires to DTU terminal block as follows.



Figure 12: Wiring Connection to DTU

29. Reinstall barrier cover using screws uninstalled in step 23.



Figure 13: Reinstall Barrier Cover

30. Replace DTU cover.
31. Install the DTU assembly on the dispenser vertical bracket as shown in Figure 14. Use the two screws, washers, and nuts as supplied in the TS-DTU/P hardware kit.



Figure 14: DTU Attached to Dispenser

32. Route power cable along bottom of electrical enclosure and attach to AC power distribution board as shown. Ensure that wiring is kept away from sharp edges and will not interfere with door closing.
33. Plug the connector from the Tokheim power harness into available connector on AC power distribution board.



Figure 15: Connect to AC Power Board

34. Attach ring terminal of ground wire to dispenser bracket using screw and nut as shown. Coil excess wiring and secure with tie-wraps to ensure that it does not interfere with door closing.



Figure 16: Attach Ground Wire

35. Find cable assembly extending from TS-VFM in dispenser hydraulics enclosure.
36. Find wiring from previously installed potted nipple assembly inside hydraulics enclosure.

37. Find two wire splice connector kits. Inside hydraulics enclosure, connect black wire from potted nipple assembly to black wire from TS-VFM flow meter by putting each lead into an opening in the wire splice connector and push fitting closed to lock.
37. Find cable extending from TS-VPS inside hydraulics enclosure. Cut yellow and blue leads from end of cable.
37. Find purple and white wires from potted nipple assembly in hydraulics enclosure. Strip wiring insulation 3/8" from end of wire.
40. Using wire nuts provided with kit, attach purple wire from potted nipple assembly to black wire of TS-VPS and white wire from potted nipple assembly to white wire of the TS-VPS.
41. Replace lower hydraulics door to side A and lock with key.
42. Lift the display assembly back to normal position and tighten with two attached screws.
43. Lock latch on display cover on B side of dispenser.
44. Close right options door on B side and lock.
45. Close printer door on B side and lock.
46. Close right options door on A side and lock.

Tokheim Premier C

This section illustrates the basic components needed to retrofit a TS-DTU module into an existing dispenser. This system can be installed in any “Non-Vapor or Vapor Ready” dispenser including dispensers with existing “Balance” or “VacAssist” piping.

1. Unlock left door from each side of dispenser and open the door.



Figure 1: Unlock Door

2. Release inside latch from left door assembly and open center door.



Figure 2: Release Inside Latch

3. Repeat step 2 for right door assembly.



Figure 3: Right Door Assembly

4. Find side B of dispenser. Side B will be the side without the AC distribution board. Unit will be installed on the right side of side B

5. Find TS-DTU/P kit and remove brackets, DTU, and fasteners from box.
6. Remove cover from DTU.
7. Install mounting bracket to DTU with two screws, nuts and washers from hardware provided with DTU as described in the General Information section. Ensure that bracket is installed on correct side as shown.

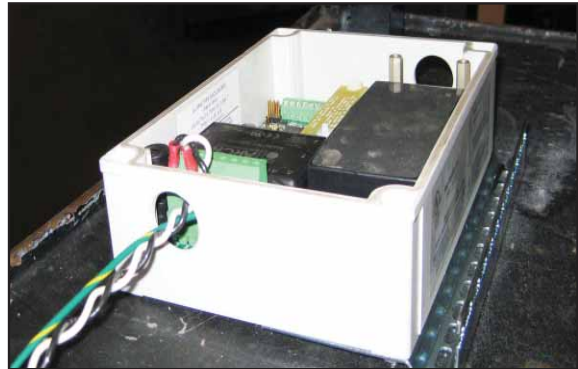

Figure 4: Attaching DTU

8. Remove two screws from IS wiring cover inside the DTU and remove cover. Keep cover and screws for future reassembly.
9. Find 90-degree fitting from IS wiring kit 020-1513. Remove nut from 90 degree fitting. Attach fitting to opening nearest IS wiring terminal block of DTU using nut previously removed.
10. Find power harness kit part number 600-0165. Find the Tokheim power harness and ground wire with ring terminal as shown in figure 4 of the Parts List. Remove tie-wraps and uncoil.
11. Pull wiring harness end with crimp connector through opening in DTU nearest terminal block J1. Attach white lead to terminal block position labeled NEUTRAL and black lead to terminal block position labeled L1 on terminal block J1 of DTU. Attach ground wire to terminal block position labeled GND of J2 on DTU.
12. Find vapor barrier plug on bottom of dispenser electronics barrier enclosure.
13. Remove lower door on side A of dispenser (side with AC distribution board).

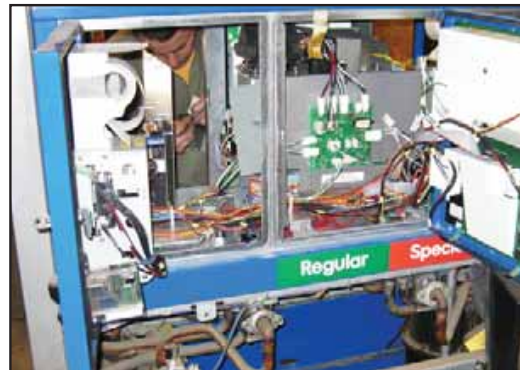

Figure 5: Remove Lower Door

Tokheim Premier C DTU Installation

14. Remove nut from top of plug using wrench.
15. Remove plug, washers, and nuts and discard all hardware.



Figure 6: Remove Nut

16. Find potted nipple assembly 131610. Untie wire ties and unwind wiring.
17. Remove and dispose of rubber washer from assembly.
18. Remove top nut from potted nipple and remove nut and one washer by pulling over wire leads. Keep nut and washer for future use.
19. Put wires from top of potted nipple assembly up from the hydraulics enclosure to the electrical enclosure. Ensure that wiring is not damaged by sharp edges.

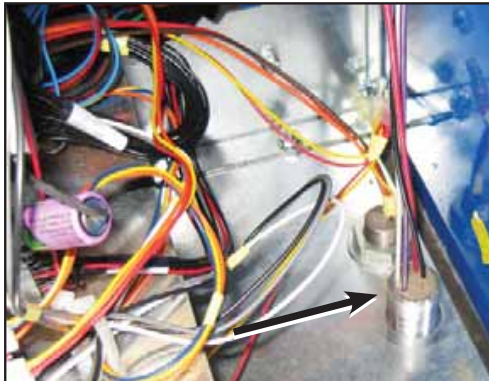

Figure 7: Potted Nipple Location

20. Push top of potted nipple assembly through opening in electrical enclosure. Pull wires inside electrical enclosure through washer and nut kept in step 8. Secure potted nipple assembly by tightening nut.



Figure 8: Potted Nipple Installed

21. Find reducer from IS wiring kit, 020-1513. From electrical enclosure, pull wires from the potted nipple assembly through $\frac{3}{4}$ " opening of reducer and attach reducer to the top of the nipple assembly.

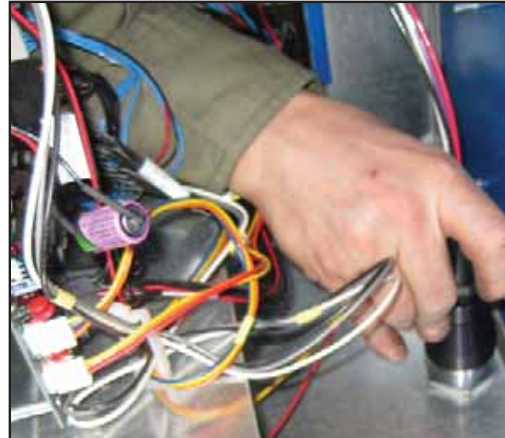

Figure 9: Attach Reducer

22. Find straight conduit fitting from IS wiring kit. From electrical enclosure, pull wires from the potted nipple fitting through opening of straight conduit assembly. Attach straight conduit fitting onto reducer.
23. Remove two screws from IS wiring cover inside the DTU and remove cover. Keep cover and screws for future reassembly.
24. Find 90-degree fitting from IS wiring kit. Remove nut from 90-degree fitting. Attach fitting to top opening of DTU using nut previously removed.
25. Find flexible conduit from IS wiring kit 020-1513. Using 90-degree fitting and straight fitting installed earlier, determine length of flexible conduit needed and cut to fit.
26. Pull wires inside electrical enclosure through flexible conduit.



Figure 10: Wire in Flexible Conduit

27. Remove nut and bushing from straight conduit fitting.

28. Push bushing onto end of flexible conduit and reattach to straight fitting using nut.



Figure 11: Flexible Conduit Connected

29. Remove bushing and nut from 90-degree conduit fitting on DTU and pull wires through the bushing.
30. Pull wires through 90-degree conduit fitting.



Figure 12: Pull wires through 90-degree fitting

31. Using nut, firmly attach flexible conduit to 90 degree conduit fitting.



Figure 13: 90-Degree Conduit Connected

32. Cut excess wire inside DTU allowing a length of 2" for terminal block wiring. Strip wire insulation $\frac{3}{8}$ " from ends of wire. Attach wires to DTU terminal block as follows.

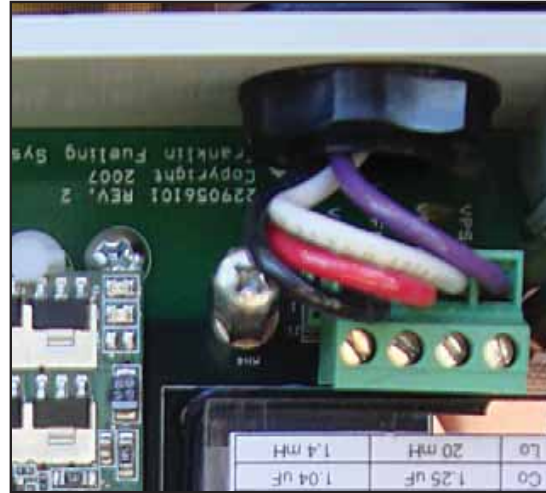

Figure 14: Wiring Connection to DTU

33. Reinstall barrier cover using screws that were removed in step 23.
34. Replace DTU cover.

Install the DTU assembly on the supporting studs located on the vertical side of the dispenser as shown in Figure 15. Use two 10-24 locking nuts to secure the assembly to the dispenser.



Figure 15: DTU Attached to Dispenser

35. Route power cable along bottom of electrical enclosure to AC power distribution board as shown. Ensure that wiring is kept away from sharp edges and will not interfere with door closing.



Figure 16: Power Cable Installation

36. Attach connector from the Tokheim power harness into available connector on AC power distribution board.



Figure 17: Attach White Connector

37. Attach ring terminal of ground wire to dispenser bracket using screw and nut as shown. Coil excess wiring with tie wraps to ensure that it does not interfere with door closing



Figure 18: Ground Wire Attached

38. Find cable assembly extending from TS-VFM vapor meter in dispenser hydraulics enclosure.
39. Find wiring from previously installed potted nipple assembly inside hydraulics enclosure.
40. Find two wire splice connector kits. Inside hydraulics enclosure connect black wire from potted nipple assembly to black wire from TS-VFM flow meter by placing each lead into an opening in the wire splice connector and push fitting closed to lock.
41. Find the cable extending from TS-VPS inside hydraulics enclosure. Cut yellow and blue leads from end of cable.
42. Find purple and white wires from potted nipple assembly in hydraulics enclosure. Strip wiring insulation $\frac{3}{8}$ " from end of wire.
43. Using wire nuts provided with kit, attach purple wire from potted nipple assembly to black wire of TS-VPS and white wire from potted nipple assembly to white wire of the TS-VPS.
44. Close right door assembly and tighten latch. Refer to Figure 3.
45. Close center door assembly and tighten latch. Refer to Figure 2.
46. Close and lock left options door.
47. Repeat steps 45 through 47 for opposite side of dispenser.

Wayne Ovation

This section illustrates the basic components needed to retrofit a TS-DTU module into an existing dispenser. This system can be installed in any “Non-Vapor or Vapor Ready” dispenser including dispensers with existing “Balance” or “VacAssist” piping.

1. Open the upper dispenser door on both sides by loosening two screws on each door.



Figure 1: Open Dispenser

2. Find TS-DTU/P kit and remove brackets, DTU, and hardware from box.
3. Remove cover from DTU.
4. Install the mounting bracket on DTU with two screws, nuts and washers from hardware provided with DTU as described in the General Information Section. Ensure that bracket is installed on correct side as shown.



Figure 2: Mounting Bracket Installed

5. Install the DTU assembly in the vertical dispenser bracket as shown in Figure 3. Use the two screws, washers, and nuts as supplied in the TS-DTU/P hardware kit.



Figure 3: Attach DTU to Dispenser

6. Find power harness kit part number 600-0166. Find the Wayne power harness as shown in Figure 4 of the Parts List. Remove tie-wraps and uncoil.
7. Pull wiring harness end with crimp connector through bottom of DTU. Attach white lead to terminal block position labeled NEUTRAL and black lead to terminal block position labeled L1 on terminal block J1 of DTU.



Figure 4: Attach Power Wiring

8. Inside dispenser, find the incoming power connection on the dispenser power supply board and disconnect.
9. Attach the Wayne power extension cable between the incoming power connector and the power supply board (Figure 5).

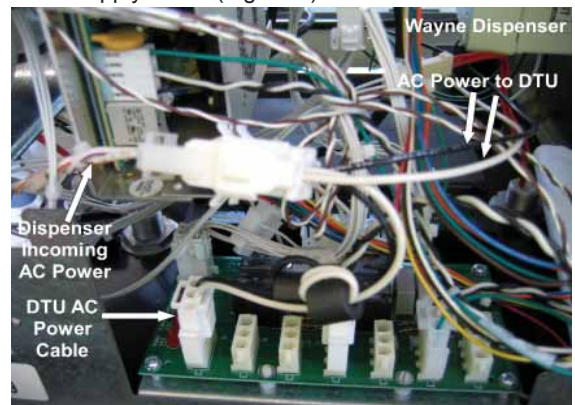

Figure 5: Attach Power extension Cable

Wayne Ovation - DTU Installation



Figure 6: Attach Power Connector to Board

10. Pull wires away from door using positioning devices included with dispenser
11. Find ground wire from power wiring harness kit. From end without ring terminal, strip 3/8" of wiring insulation.
12. Attach ground wire to terminal block position labeled GND of J2 on DTU.
13. Attach ring terminal of ground wire to dispenser bracket using screw and nut as shown. Wind excess wiring and attach with tie wraps to ensure that it does not interfere with door closing.

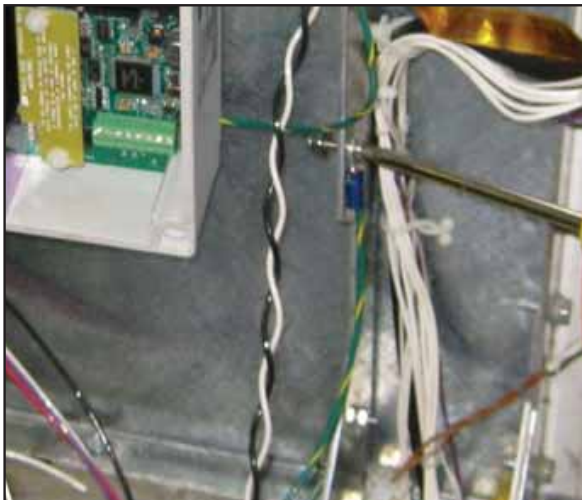

Figure 7: Attach Ground Wire to Frame

14. Find the side of dispenser opposite of power supply. Remove lower door on that side by loosening two screws. Set door aside and save for later assembly.
15. Remove nut from hole plug located at the bottom of the electrical enclosure using two wrenches. Remove bolt, nut, and washers and dispose of them.



Figure 8: Remove Hole Plug

16. Find potted nipple assembly, 131610.
17. Remove and dispose of rubber washer from assembly.
18. Turn top nut from potted nipple counter-clockwise and remove nut and one washer by pulling it over wire leads. Keep nut and washer for future use.
19. Using 3/4" conduit hole punch, increase size of 1/2" hole exposed after following step 14.



Figure 9: Increase Hole Size

20. Push wires from top of potted nipple assembly up from the hydraulics enclosure through to the electrical enclosure. Make sure that wiring is not damaged by sharp edges.



Figure 10: Push Wire to Electrical Enclosure

21. Push top of potted nipple assembly through opening in electrical enclosure. Pull the wires inside electrical enclosure through washer and nut retained in step 18. Tighten potted nipple assembly nut.



Figure 11: Install Potted Nipple

22. Find reducer in IS conduit kit. From electrical enclosure, pull wires from the potted nipple assembly through $\frac{3}{4}$ " opening of reducer and thread reducer to the top of the nipple assembly.
23. Find straight conduit fitting from IS wiring kit. From electrical enclosure, pull wires from the potted nipple assembly through opening of straight conduit fitting. Turn straight conduit fitting clockwise onto reducer.
24. Remove two screws from IS wiring cover inside the DTU and remove cover. Retain cover and screws for future reassembly.



Figure 12: Remove Wiring Cover

25. Find 90-degree fitting from IS conduit kit. Remove nut from 90-degree fitting. Attach fitting to top opening of DTU using nut previously removed.



Figure 13: Attach 90-Degree Fitting

26. Find flexible conduit fitting in IS conduit kit, 020-1513. Using 90-degree fitting and straight fitting installed earlier, determine length of flexible conduit needed and cut to fit.
27. Pull wires inside electrical enclosure through IS conduit assembly.
28. Remove nut and bushing from straight conduit fitting.

29. Push bushing onto end of flexible conduit and reattach to straight fitting using nut.



Figure 14: Attach Flexible Conduit to Potted Nipple

30. Remove bushing and nut from 90-degree fitting on DTU and pull wiring and flexible conduit through.
31. Pull wires through 90-degree fitting and pull into the DTU enclosure.
32. Use nut and attach flexible conduit to 90-degree fitting.



Figure 15: Attach Flexible Conduit to 90-Degree Fitting

33. Cut excess wire inside DTU allowing a length of 2" for terminal block wiring. Strip insulation 3/8" from end of wire. Attach wires to DTU terminal block as follows



Figure 16: Terminal Block Wiring

34. Reinstall barrier cover using screws removed in step 24.
35. Replace DTU cover.



Figure 17: Attach Cover to DTU

36. Find cable assembly extending from TS-VFM vapor meter in dispenser hydraulics enclosure.
37. Locate wiring from previously installed potted nipple assembly inside hydraulics enclosure.
38. Find two-wire splice connector kits. Inside hydraulics enclosure connect black wire from potted nipple assembly to black wire from TS-VFM flow meter by placing each lead into an opening in the wire splice connector and push fitting closed to lock.
39. Find cable extending from TS-VPS inside hydraulics enclosure. Cut yellow and blue leads from end of cable.
40. Find purple and white wires from potted nipple assembly in hydraulics enclosure. Strip wiring insulation at end 3/8".
41. Using wire nuts provided with kit, attach purple wire from potted nipple assembly to black wire of TS-VPS and attach white wire from potted nipple assembly to white wire of the TS-VPS.
42. Replace lower hydraulics door using two screws on door.
43. Close dispenser doors on each side of the unit and firmly attach with two screws located in each door.

Wayne Ovation - DTU Installation

Wayne Vista 1

This section illustrates the basic components needed to retrofit a TS-DTU module into an existing dispenser. This system can be installed in any "Non-Vapor or Vapor Ready" dispenser including dispensers with existing "Balance" or "VacAssist" piping.

1. Remove lower brand panel door using key locks.
2. Remove two thumb screws from each side of bezel and pull bezel off of dispenser
3. Remove product select connector from center bezel.



Figure 1: Lower Door Panel Open

4. Remove keypad data P2 cable, and LCD power connectors from door

NOTE: Alternate display assembly will require the removal of a fourth connector from the LCD/keypad assembly.



Figure 2: 4th Connector

5. Remove bezel and retain for future reassembly
6. Repeat steps 2 through 5 for other side
7. Using two wrenches, remove nut from hole plug found at the bottom of the electrical enclosure. Remove bolt, nut, and washers and dispose of them.



Figure 3: Remove Hole Plug

8. Find potted nipple assembly, 131610. Open wire ties and unwind wiring.
9. Remove and dispose of rubber washer from assembly.
10. Remove top nut from potted nipple and remove nut and one washer by pulling over wire leads. Keep nut and washer for future use.
11. Pull top wires of potted nipple assembly from the hydraulics enclosure to the electrical enclosure. Ensure that wiring is not damaged by sharp edges.
12. Pull top of potted nipple assembly through opening in electrical enclosure. Route wires inside electrical enclosure through washer and nut retained in step 10. Attach potted nipple assembly by tightening nut.



Figure 4: Potted Nipple Installed

13. Find reducer from IS conduit kit, 020-1513. From electrical enclosure, pull wires from the potted nipple assembly through $\frac{3}{4}$ " opening of reducer and attach reducer to the top of the nipple assembly.
14. From electrical enclosure, pull wires from the potted nipple assembly through opening of straight conduit. Attach straight conduit fitting onto reducer.



Figure 5: Straight Conduit Installed

15. Find TS-DTU/P kit and remove brackets, DTU, and hardware from box.
16. Remove cover from DTU.
17. Attach mounting bracket to DTU with two screws, nuts and washers from hardware provided with DTU as described in the General Information Section. Ensure that bracket is installed on correct side as shown in Figure 6.



Figure 6: Mounting Bracket on DTU

18. Remove two screws from IS wiring cover inside the DTU and remove cover. Keep cover and screws for reassembly.
19. Find 90-degree fitting in IS conduit kit, 020-1513. Remove nut from 90-degree fitting. Attach fitting to opening nearest IS wiring terminal block of DTU using nut previously removed.



Figure 7: 90-Degree Fitting Installed

Note: The installation of the DTU in the dispenser will occur after all connections have been made to the DTU.

20. Find power harness kit part number 600-0165. Find the Wayne power harness and ground wire with ring terminal as shown in figure 4 of the Parts List. Remove tie-wraps and uncoil.
21. Push wiring harness end with crimp connector through opening in DTU nearest power terminal block J1. Attach white lead to terminal block position labeled NEUTRAL and black lead to terminal block position labeled L1 on terminal block J1 of DTU. Attach ground wire to terminal block position labeled GND of J2 on DTU.



Figure 8: DTU Wiring

22. Cut connector off the Wayne power harness kit. Strip wire insulation 3/8" from the end of the wire.
23. Pull wire underneath bracket, along bottom of dispenser and through wire bushing in display assembly.



Figure 9: Power Harness Wiring

24. Find black/white pair of twisted wires inside display assembly. Cut wires, forming four leads and uncoil. Strip wire insulation 3/8" from the end of the wire.

25. Using wire nuts provided, connect all three white wires together. Connect three black wires together.

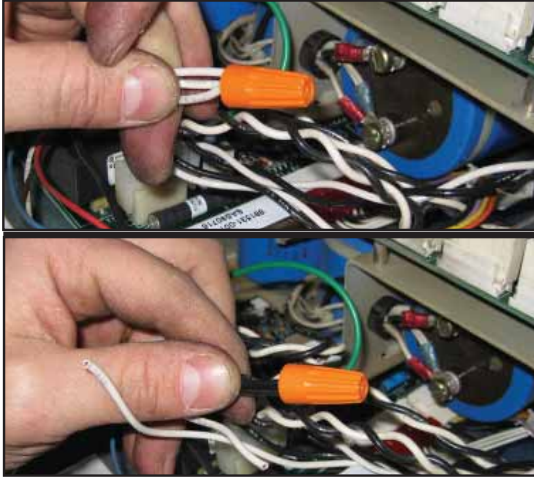

Figure 10: Connect Wires

26. Use tie-wrap to attach connections together.



Figure 11: Wrap Wires

27. Attach wiring from power wiring harness to the side of the display assembly using adhesive backed anchor and wire tie.



Figure 12: Attach Power Wiring Harness

28. Close display assembly and firmly attach using two screws. Ensure that all wiring is free of sharp edges and pinching when doors close. If sharp edges or pinching is observed, use additional tie wraps and anchors to reroute wiring as necessary.
29. Attach ring terminal of ground wire to dispenser bracket using screw and nut as shown. Wind excess wiring and firmly attach with tie wraps to ensure that it does not interfere with door closing.

30. Find straight conduit fitting and flexible conduit from IS conduit kit, 020-1513. Remove nut and bushing from straight conduit fitting. Push bushing on one end of flexible conduit. Pull wires from nipple assembly through bushing/flexible conduit and attach flexible conduit to straight conduit fitting using nut.



Figure 13: Attach Flexible Conduit

31. Remove nut and bushing from the 90-degree conduit fitting and feed flexible conduit through nut. Put bushing on unattached end of flexible conduit. Pull wires from flexible conduit through the 90-degree conduit fitting and pull excess wire into DTU. Use nut to attach flexible conduit to 90-degree fitting.

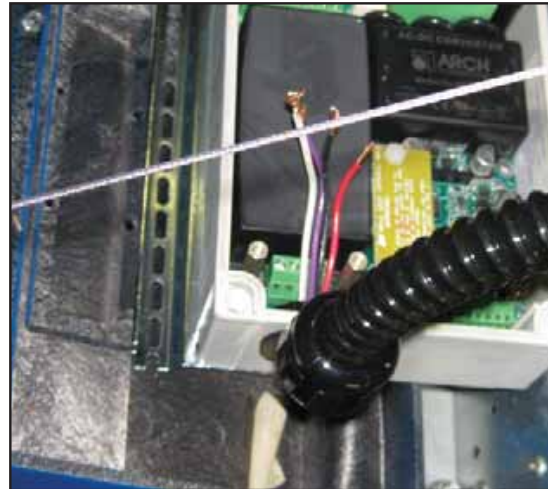

Figure 14: Flexible Conduit DTU Connection

32. Cut excess wire inside DTU allowing a length of 2" for terminal block wiring. Strip wire insulation 3/8" from the end of the wire.

Wayne Vista 1 - DTU Installation

33. Attach wires to DTU terminal block as follows



Figure 15: Wires Connected to DTU

34. Reinstall barrier cover using screws that were removed in step 20.
35. Replace DTU cover.
36. Install the DTU assembly on the horizontal cross bracket as shown in Figure 16. Use the two screws, washers, and nuts as supplied in the TS-DTU/P hardware kit. Take care that the flexible conduit does not interfere with the electronics on the side of the dispenser.



Figure 16: DTU Installed with Cover On

Note: Moving the 90-degree conduit fitting on DTU slightly away from the dispenser PCB board will aid in separating the conduit from the that board.

37. Find cable assembly extending from TS-VFM vapor meter in dispenser hydraulics enclosure.
38. Find wiring from previously installed potted nipple assembly inside hydraulics enclosure.

39. Find two wire splice connector kits. Inside hydraulics enclosure, connect black wire from potted nipple assembly to black wire from TS-VFM flow meter by placing each lead into an opening in the wire splice connector and push fitting closed to lock.
40. Locate cable extending from TS-VPS inside hydraulics enclosure. Cut yellow and blue leads from end of cable.
41. Find purple and white wires from potted nipple assembly in hydraulics enclosure. Strip wire insulation 3/8" from the end of the wire.
42. Using wire nuts provided with kit, attach purple wire from potted nipple assembly to black wire of TS-VPS. Attach white wire from potted nipple assembly to white wire of the TS-VPS.
43. Reinstall lower hydraulic door using key-lock
44. Reinstall all connectors removed in step 3 & 4.
45. Close the bezel on the dispenser and secure using two thumb screws from each side of the bezel.
46. Repeat steps 44 & 45 for the opposite side of the dispenser.

Wayne Vista 2

This section illustrates the basic components needed to retrofit a TS-DTU module into an existing dispenser. This system can be installed in any "Non-Vapor or Vapor Ready" dispenser including dispensers with existing "Balance" or "VacAssist" piping.

1. Using key-lock, remove lower door on B side of dispenser. B side of the dispenser does not have dispenser marking at the base.
2. Open upper dispenser door on both sides by loosening two screws on each door.



Figure 1: Open Upper Dispenser Door

3. On "B" side, remove two screws holding display assembly and carefully lower into resting position.



Figure 2: Carefully Lower Door

4. DTU will be installed in the location shown below. (The DTU will not be installed until step 21) Examine the bottom of the electrical enclosure to determine location of unused hole plugs and choose the appropriate side of dispenser.



Figure 3: DTU Installed

Note: Hole plugs beneath plastic catch pans cannot be used as there is not enough clearance to install conduit fittings.

5. Remove lower dispenser door using key lock closest to the hole plug chosen in step 2.
6. Using two wrenches, remove nut from hole plug found at the bottom of the electrical enclosure. Remove bolt, nut, and washers and dispose of them.



Figure 4: Remove Hole Plug

7. Find potted nipple assembly, 131610. Open wire ties and unwind wiring.
8. Remove and dispose of rubber washer from assembly.
9. Remove top nut from potted nipple and remove nut and one washer by pulling over wire leads. Keep nut and washer for future use.
10. Pull top wires of potted nipple assembly from the hydraulics enclosure to the electrical enclosure. Ensure that wiring is not damaged by sharp edges.
11. Pull top of potted nipple assembly through opening in electrical enclosure. Route wires inside electrical enclosure through washer and nut retained in step 9. Attach potted nipple assembly by tightening nut.



Figure 5: Potted Nipple Installed

12. Find reducer from IS conduit kit, 020-1513. From electrical enclosure, pull wires from the potted nipple assembly through $\frac{3}{4}$ " opening of reducer and attach reducer to the top of the nipple assembly.

Wayne Vista 2 - DTU Installation

- From electrical enclosure, pull wires from the potted nipple assembly through opening of straight conduit. Attach straight conduit fitting onto reducer.



Figure 6: Straight Conduit Installed

- Find TS-DTU/P kit and remove brackets, DTU, and hardware from box.
- Remove cover from DTU.
- Install mounting bracket to DTU with two screws, nuts and washers from hardware provided with DTU, as described in the General Information Section. Make sure that bracket is installed on correct side as shown in Figure 7.



Figure 7: Mounting Bracket on DTU

- Remove two screws from IS wiring cover inside the DTU and remove cover. Keep cover and screws for reassembly.
- Find 90-degree fitting in IS conduit kit, 020-1513. Remove nut from 90-degree fitting. Attach fitting to opening nearest IS wiring terminal block of DTU using nut previously removed.

Note: The installation of the DTU in the dispenser will occur after all connections have been made to the DTU.



Figure 8: 90-Degree Fitting Installed

- Find power harness kit part number 600-0165. Find the Wayne power harness and ground wire with ring terminal as shown in figure 4 of the Parts List. Remove tie-wraps and uncoil.
- Push wiring harness end with crimp connector through opening in DTU nearest power terminal block J1. Attach white lead to terminal block position labeled NEUTRAL and black lead to terminal block position labeled L1 on terminal block J1 of DTU. Attach ground wire to terminal block position labeled GND of J2 on DTU.



Figure 9: DTU Wiring

- Cut both connectors off the Wayne power harness kit. Strip wire insulation 3/8" from the end of the wire.
- Pull wire underneath bracket, along bottom of dispenser and through wire bushing in display assembly.



Figure 10: Power Harness Wiring

- Dispenser supply power wires from the potted nipple. Cut wires 6 to 12 inches away from the potted nipple, forming four leads and uncoil. Strip wire insulation 3/8" from the end of each wire.

24. Using wire nuts provided, connect the incoming power, one end of the wire with the ferrite, and a wire for the DTU power.



Figure 11: Connect Wires

25. Use tie-wrap to attach connections together.

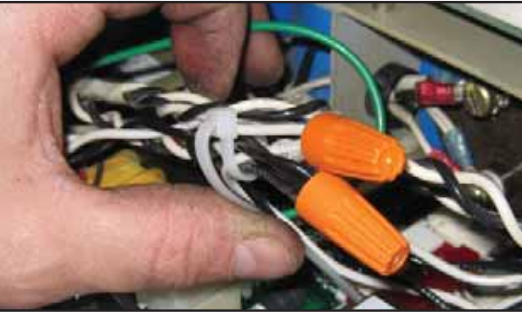

Figure 12: Wrap Wires

26. Attach wiring from power wiring harness to the side of the display assembly using adhesive backed anchor and wire tie.



Figure 13: Attach Power Wiring Harness

27. Close display assembly and firmly attach using two screws. Ensure that all wiring is free of sharp edges and pinching when doors close. If sharp edges or pinching is observed, use additional tie wraps and anchors to reroute wiring as necessary.

28. Attach ring terminal of ground wire to dispenser bracket using screw and nut as shown. Wind excess wiring and firmly attach with tie wraps to ensure that it does not interfere with door closing.
29. Find straight conduit fitting and flexible conduit from IS conduit kit, 020-1513. Remove nut and bushing from straight conduit fitting. Push bushing on one end of flexible conduit. Pull wires from nipple assembly through bushing/flexible conduit and attach flexible conduit to straight conduit fitting using nut.



Figure 14: Attach Flexible Conduit

30. Remove nut and bushing from the 90-degree conduit fitting and feed flexible conduit through nut. Put bushing on unattached end of flexible conduit. Pull wires from flexible conduit through the 90-degree conduit fitting and pull excess wire into DTU. Use nut to attach flexible conduit to 90-degree fitting.

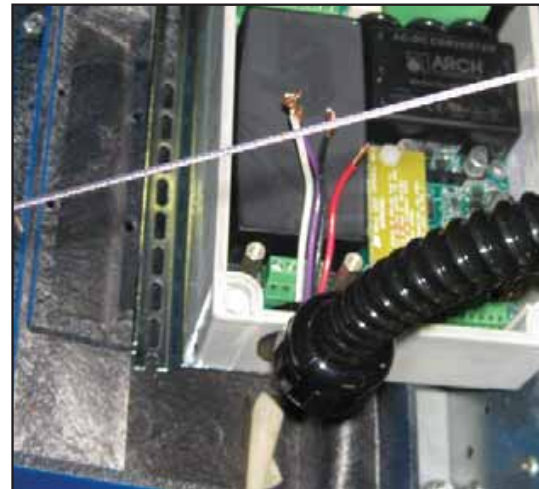

Figure 15: Flexible Conduit DTU Connection

31. Cut excess wire inside DTU allowing a length of 2" for terminal block wiring. Strip wire insulation 3/8" from the end of the wire.

32. Attach wires to DTU terminal block as follows



Figure 16: Wires Connected to DTU

33. Reinstall barrier cover using screws that were removed in step 20.
34. Replace DTU cover.
35. Install the DTU assembly on the horizontal cross bracket as shown in Figure 17. Use the two screws, washers, and nuts as supplied in the TS-DTU/P hardware kit. Make sure the flexible conduit does not interfere with electronics inside dispenser.



Figure 17: DTU Installed with Cover On

Note: Moving the 90-degree conduit fitting on DTU slightly away from the dispenser PCB board will aid in separating the conduit from the that board.

36. Find cable assembly extending from TS-VFM vapor meter in dispenser hydraulics enclosure.
37. Find wiring from previously installed potted nipple assembly inside hydraulics enclosure.

38. Find two wire splice connector kits. Inside hydraulics enclosure, connect black wire from potted nipple assembly to black wire from TS-VFM flow meter by placing each lead into an opening in the wire splice connector and push fitting closed to lock.
39. Locate cable extending from TS-VPS inside hydraulics enclosure. Cut yellow and blue leads from end of cable.
40. Find purple and white wires from potted nipple assembly in hydraulics enclosure. Strip wire insulation 3/8" from the end of the wire.
41. Using wire nuts provided with kit, attach purple wire from potted nipple assembly to black wire of TS-VPS. Attach white wire from potted nipple assembly to white wire of the TS-VPS.
42. Reinstall lower hydraulic door using key-lock
43. Close upper dispenser door on each side by tightening two screws, refer to figure 1.

Wayne Vista 3

This section illustrates the basic components needed to retrofit a TS-DTU module into an existing dispenser. This system can be installed in any “Non-Vapor or Vapor Ready” dispenser including dispensers with existing “Balance” or “VacAssist” piping.

1. Open upper dispenser door on both sides by loosening two screws on each door.



Figure 1: Open Door

2. Find the location where the DTU will be installed. (The DTU will not be installed until step 21). Examine the bottom of the electrical enclosure to determine location of unused hole plugs and choose the appropriate side of dispenser.



Figure 2: DTU Location

Note: Hole plugs beneath plastic catch pans cannot be used as there is not significant clearance to install conduit fittings.

3. Remove lower dispenser door using key lock closest to the hole plug chosen in step 2.



Figure 3: Unlock Lower Door

4. Using two wrenches, remove nut from hole plug located at the bottom of the electrical enclosure. Remove bolt, nut, and washers and dispose of them.



Figure 4: Removing Hole Plug

Note: Opening created in the bottom of the electrical enclosure may be $\frac{1}{2}$ " or $\frac{3}{4}$ ". If hole is $\frac{1}{2}$ ", it will need to be increased in $\frac{3}{4}$ " in step 5. For openings that are $\frac{3}{4}$ ", skip to Step 6.

5. Using $\frac{3}{4}$ " conduit hole punch, increase size of $\frac{1}{2}$ " hole to $\frac{3}{4}$ ".
6. Find and remove potted nipple assembly, 131610.
7. Remove wire ties and unwind wiring.
8. Remove and dispose of rubber washer from assembly.
9. Remove top nut from potted nipple and remove nut and one washer by pulling over wire leads. Keep nut and washer for future use.
10. Pull top wires of potted nipple assembly from the hydraulics enclosure to the electrical enclosure. Ensure that wiring is not damaged by sharp edges.
11. Pull top of potted nipple assembly through opening in electrical enclosure. Pull wires inside electrical enclosure through washer and nut retained in step 8. Firmly attach potted nipple assembly by tightening nut.

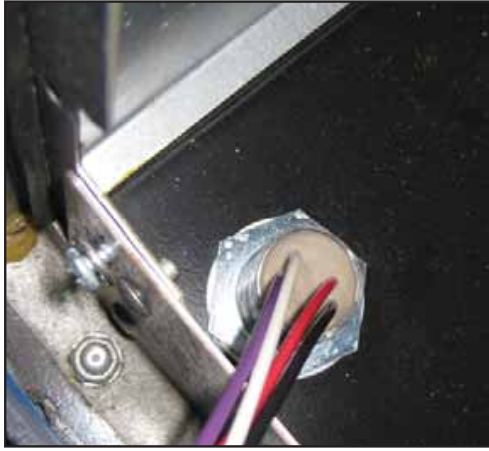

Figure 5: Potted Conduit Installed

12. Find reducer from IS conduit kit PN 020-1513. From electrical enclosure, pull wires from the potted nipple assembly through $\frac{3}{4}$ " opening of reducer and thread reducer to the top of the nipple assembly.
13. Find straight conduit fitting from IS conduit kit 020-1513. From electrical enclosure, pull wires from the potted nipple fitting through opening of straight conduit fitting. Turn straight conduit fitting clockwise onto reducer.



Figure 6: Straight Conduit Installed

14. Find TS-DTU/P from kit and remove brackets, DTU, and hardware from box.
15. Remove cover from DTU.
16. Install mounting bracket to DTU with two screws, nuts and washers from hardware provided with DTU as described in the general Information Section. Ensure that bracket is installed on correct side as shown.



Figure 7: DTU Mounting Bracket Installed

17. Remove two screws from IS wiring cover inside the DTU and remove cover. Keep cover and screws for future reassembly.
18. Find 90-degree fitting from IS wiring kit. Remove nut from 90-degree fitting. Attach fitting to opening nearest IS wiring terminal block of DTU using nut previously removed.

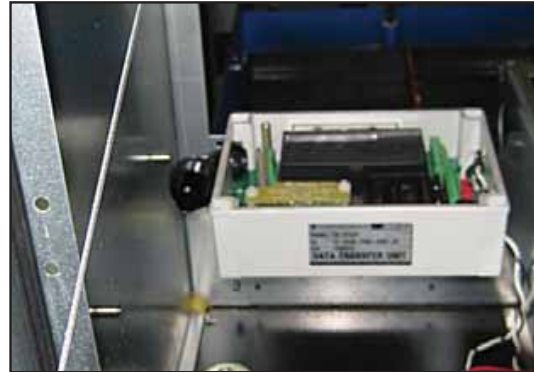

Figure 8: 90-Degree Fitting Installed

Note: The installation of the DTU in the dispenser will occur after all connections have been made to the DTU.

19. Find power harness kit part number 600-0166. Find the Wayne power harness and ground wire with ring terminal as shown in figure 4 of the Parts List. Remove tie-wraps and uncoil.
20. Push wiring harness end with crimp connector through opening in DTU nearest power terminal block J1. Attach white lead to terminal block position labeled NEUTRAL and black lead to terminal block position labeled L1 on terminal block J1 of DTU. Attach ground wire to terminal block position labeled GND of J2 on DTU.

- Find the incoming power connection on the dispenser power supply board shown in Figure 9



Figure 9: Attach White Connector

- Attach the new Wayne power extension cable between the incoming power connector and the power supply board.

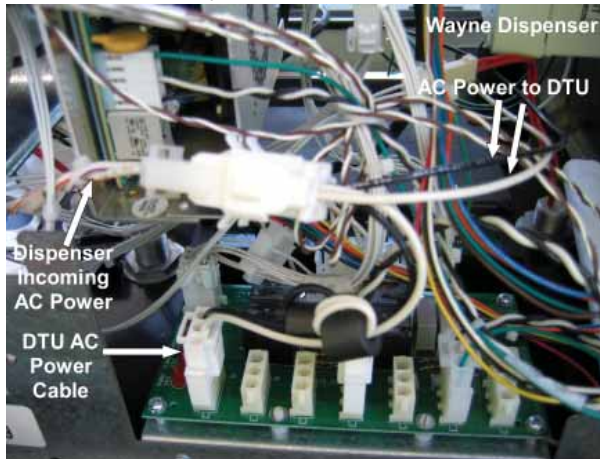

Figure 10: Attache Power Cable

- Find straight conduit fitting and flexible conduit from IS conduit kit, 020-1513. Remove nut and bushing from straight conduit fitting. Put bushing on one end of flexible conduit.
- Determine length of flexible conduit needed and cut to fit.
- Push wires from nipple assembly through bushing / flexible conduit and attach flexible conduit to straight conduit fitting using nut.



Figure 11: Flexible Conduit Installation

- Remove nut and bushing from 90-degree conduit fitting and push flexible conduit through nut. Push bushing on unattached end of flexible conduit. Pull wires from flexible conduit through the 90-degree conduit fitting and pull excess wire into DTU. Attach flexible conduit to 90-degree fitting with nut.



Figure 12: 90-Degree Fitting Installed

- Cut excess wire inside DTU allowing a length of 2" for terminal block wiring. Strip wire insulation 3/8" from end of wire. Attach wires to DTU terminal block as follows.



Figure 13: Wires attached to DTU

- Reinstall barrier cover using screws set aside in step 17.
- Replace DTU cover.

Wayne Vista 3 - DTU Installation

30. Install the DTU assembly on the horizontal cross bracket as shown in Figure 14. Use the two screws, washers, and nuts as supplied in the TS-DTU/P hardware kit.



Figure 14: DTU Mounted

31. Attach ring terminal of ground wire to dispenser bracket using screw and nut as shown. Coil excess wiring and firmly attach with tie wraps to ensure that it does not interfere with door closing.

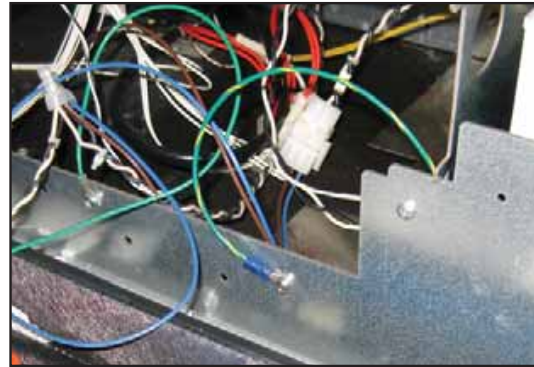

Figure 15: Ground Wire Connected

32. Find cable assembly extending from TS-VFM vapor meter in dispenser hydraulics enclosure.
33. Find wiring from previously installed potted nipple assembly inside hydraulics enclosure.
34. Find two wire splice connector kits. Inside hydraulics enclosure, connect black wire from potted nipple assembly to black wire from TS-VFM flow meter by putting each lead into an opening in the wire splice connector and push fitting closed to lock.
35. Find cable from TS-VPS inside hydraulics enclosure. Clip yellow and blue leads from end of cable.
36. Find purple and white wires from potted nipple assembly in hydraulics enclosure. Strip wiring insulation 3/8" from end of wire.
37. Using wire nuts provided with kit connect purple wire from potted nipple assembly to black wire of TS-VPS. Connect white wire from potted nipple assembly to white wire of the TS-VPS.
38. Reinstall lower hydraulic door using key-lock.
39. Close dispenser doors on each side of the unit and firmly attach with two screws located in each door.



Console DTU (Data Transfer Unit)

Installation Instructions

Overview

The TS-DTU will be installed in the dispenser when it is used as a Remote DTU or inside the building when used as a Console DTU. These installation instructions are to be used for installing the TS-DTU inside the building.

When used as a Console DTU, data is received from the Remote DTU units via power line communication. The data is then sent to the System Console (TS-550/5000/EMS) for processing. Unlike the Remote DTU units, the Console DTU will have no Intrinsically safe sensors connected to it.

Site Inspection

A licensed electrician should perform a site inspection before installing any equipment. The Console DTU must be connected to all electrical phases that supply power to dispensers containing Remote DTUs.

Check for any electrical isolation. Isolation between the electrical panel and the dispenser can result in poor or no communication with the DTU. Make sure there is not a power conditioner between the Console DTU and dispenser power.

Installation Procedure

Tools and Supplies Needed

• 1/2 " Cord grip/strain relief	• Small slotted screwdriver
• Multimeter	• Mounting screws
• 2-wire shielded cable	• 14 AWG wire (one for each phase and ground)

Step 1 – Remove System Power

Remove power from the TS-5XXX Series System Console and do NOT return power to the System Console or to the Console DTU until instructed to do so.



Electrical Hazard! Always disconnect power supplies before installing or servicing the console TS-DTU. Use proper lock-out and tag-out procedures to ensure no power is accidentally applied to the system. Failure to do so could result in severe injury or death.

Step 2 – Mounting the Console DTU

Mount the Console DTU as close to the circuit breaker panel that is supplying the dispenser(s). Remove the cover and insert a screw (not supplied) into each of the four corners of the enclosure. Mount the unit to the wall. You may optionally use the supplied mounting brackets.

Step 3 – Power Connection

The Console DTU may use the same circuit breaker as the System Console but **DO NOT** connect the power for the Console DTU inside the Console enclosure. Install a junction box or wire the Console directly to the circuit breaker panel.

Ideally, the circuit selected for the console power will be on the same phase as all dispensers and no further power connections will be required. If any dispensers are on a different phase, run wires from the L2 and L3 connections on the Console DTU to the appropriate circuit breakers for the required extra phases. If there is any question about what phase some of the dispensers are on, it is recommended to connect all three phases to the Console DTU.

Connect the neutral for the Console DTU to the same neutral supplying the dispensers. If there is not a clean neutral return for the DTU then poor quality may result.

Warning: Cycling power to the Console DTU without powering off the System Console will cause the System Console to reboot.

Installer must use conduit for connecting the DTU on the power connection side.

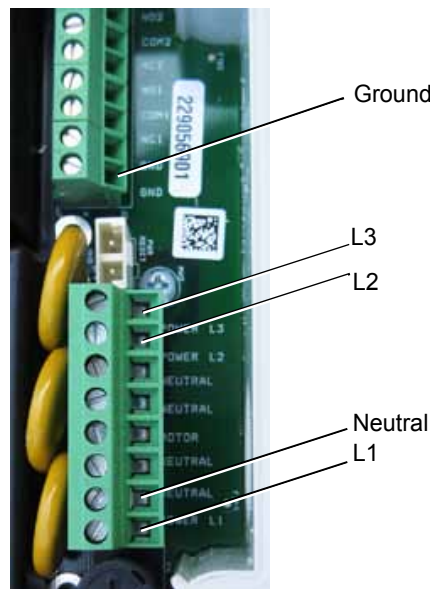

Figure 1: Power Connections to the Console DTU

Step 4 – Bus Termination Jumper Removal

The Console DTU will provide system bus termination when installed and running. Therefore the system bus termination currently provided by the Power Supply Module needs to be removed. Refer to the TS-5XXX Series Installation Guide for instructions on how to remove a module.

Be extremely careful when removing the power supply module so it does not rub against any other part of the system. After it is removed from the system, locate the system bus termination jumper JP1 and remove it (Figure 2).

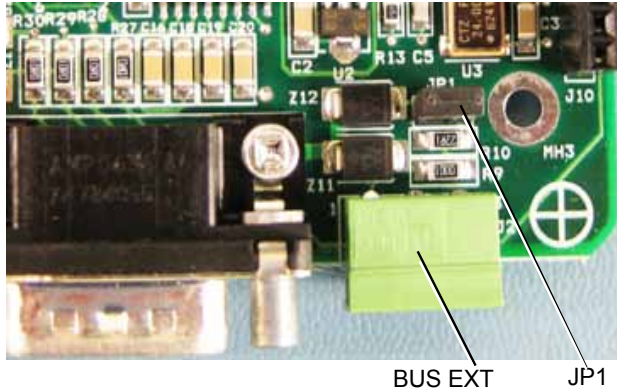

Figure 2: JP1 Location on the Power Supply Module

Re-Install the power supply module, securing it properly in place and replace the communication bracket as required.

Step 5 – Data Connection

The Console DTU acts as an external System Console module and therefore must be connected to the system bus. This is made possible via the external BUS EXT connection, located on the power supply module.

The bus connection requires 2-wire shielded cable and FFS recommends Belden 87761. On the Console DTU, the cable enters through the Intrinsicly Safe (I.S.) opening but is connected outside of the I.S. area, which is not used in the Console DTU. Therefore the I.S. shield will need to be removed and discarded. Secure the bus cable on the Console DTU side using a cord grip.

On the System Console communications bracket, locate the BUS EXT connector (Figure 4). The connector is removable for convenient wiring. Refer to the following table and make the proper BUS (HIGH, LOW, GND) connections (Figure 3). To make the necessary connections between the System Console and the DTU, plug the BUS EXT connector back into the System Console. Secure the bus cable so it is not accidentally disconnected.

Belden Cable	BUS EXT	Console DTU Connection
Red Wire	HIGH	HIGH
Black Wire	LOW	LOW
Shield	GND	GND

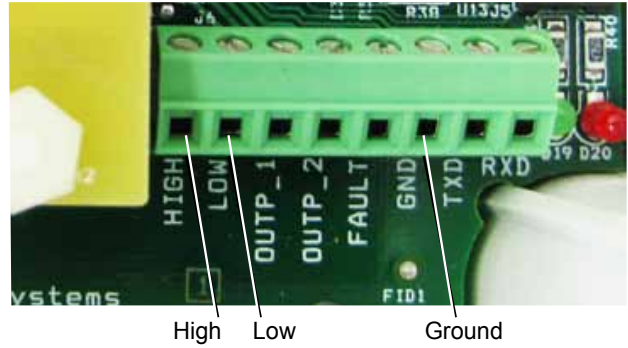

Figure 3: Console DTU BUS EXT Connection

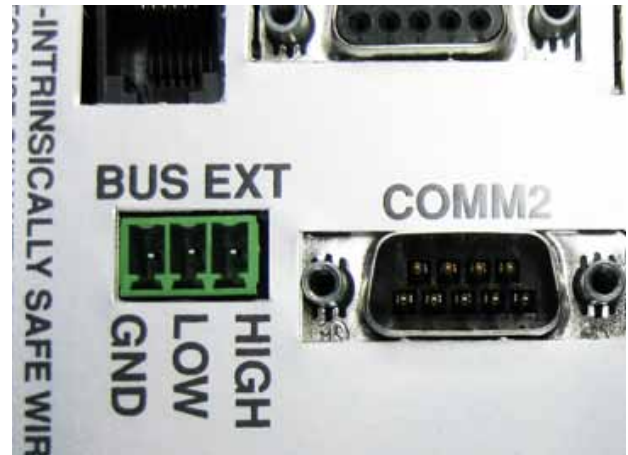

Figure 4: Console Side BUS EXT Connection

Step 6 – Review All Connections

Review power and data connections and make sure the cable is attached securely. Finally replace the Console DTU Cover.

Step 7 – Power Up

Return power to the System Console and the newly installed Console DTU.

Related Documents

- 000-2146 DTU Dispenser Retrofit Manual
- 000-2142 T5 Console Programming Manual, rev D or higher
- 000-2150 T5 Installation Manual
- 000-2058 VRM IOM manual rev C or higher

- 1) THE MODEL TS-DTU/P SHALL NOT BE CONNECTED TO ANY EQUIPMENT WHICH USES OR GENERATES GREATER THAN 250V. EACH GROUND TERMINAL SHALL BE CONNECTED TO A SUITABLE SYSTEM EARTH GROUND. THE DC RESISTANCE BETWEEN GROUND TERMINALS AND EARTH GROUND SHALL BE LESS THAN 1 OHM.
- 2) THE MODEL TS-DTU/P WIRING SHALL BE INSTALLED IN ACCORDANCE WITH THE FOLLOWING LOCAL CODES. CONDUCTORS OF DIFFERENT INTRINSICALLY SAFE CIRCUITS RUN IN THE SAME CABLE/CONDUIT MUST HAVE AT LEAST 0.25cm OF INSULATION.

- 4) CAPACITANCE AND INDUCTANCE OF THE FIELD WIRING FROM THE INTRINSICALLY SAFE EQUIPMENT TO THE CABLE TERMINALS AND FROM THE CABLE TERMINALS TO THE EQUIPMENT SHALL BE LIMITED TO THE VALUES SHOWN IN TABLE 1.1A. CAPACITANCE (C) PLUS INTRINSICALLY SAFE EQUIPMENT CAPACITANCE (CE) MUST BE LESS THAN THE MARKED CAPACITANCE (CG) SHOWN IN ANY BARBER USED. THE SAME APPLIES FOR INDUCTANCE (L) AND LO RESPECTIVELY. THE FOLLOWING VALUES SHALL BE USED: C=60pF/ft., L=0.0067mH/ft., L=0.025mH/ft. (0.25μH/m).
- 5) WIRING, CABLES AND SEALS MUST BE INSTALLED IN ACCORDANCE WITH THE NEC, IEC OR OTHER APPLICABLE NATIONAL OR LOCAL CODES.
- 6) USE ONLY CABLE THAT IS SPECIFIED IN USER INSTALLATION MANUAL OR LISTED EQUIVALENT FOR THE INSTALLATION OF LIQUID LEVEL PROBES.

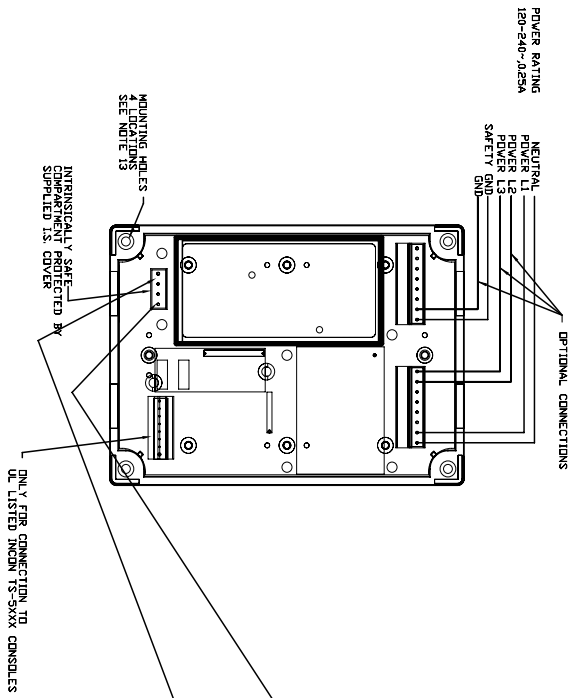

- 7) USE THE FOLLOWING WIRE TYPES:
 FOR 15 AWG WIRING USE 18AWG MINIMUM OIL AND GASOLINE RESISTANT TYPES, 1FFN, THWN, THHN, THHW, THX, THY, THZ, THZ-2, THZ-3, THZ-4, THZ-5, THZ-6, THZ-7, THZ-8, THZ-9, THZ-10, THZ-11, THZ-12, THZ-13, THZ-14, THZ-15, THZ-16, THZ-17, THZ-18, THZ-19, THZ-20, THZ-21, THZ-22, THZ-23, THZ-24, THZ-25, THZ-26, THZ-27, THZ-28, THZ-29, THZ-30, THZ-31, THZ-32, THZ-33, THZ-34, THZ-35, THZ-36, THZ-37, THZ-38, THZ-39, THZ-40, THZ-41, THZ-42, THZ-43, THZ-44, THZ-45, THZ-46, THZ-47, THZ-48, THZ-49, THZ-50, THZ-51, THZ-52, THZ-53, THZ-54, THZ-55, THZ-56, THZ-57, THZ-58, THZ-59, THZ-60, THZ-61, THZ-62, THZ-63, THZ-64, THZ-65, THZ-66, THZ-67, THZ-68, THZ-69, THZ-70, THZ-71, THZ-72, THZ-73, THZ-74, THZ-75, THZ-76, THZ-77, THZ-78, THZ-79, THZ-80, THZ-81, THZ-82, THZ-83, THZ-84, THZ-85, THZ-86, THZ-87, THZ-88, THZ-89, THZ-90, THZ-91, THZ-92, THZ-93, THZ-94, THZ-95, THZ-96, THZ-97, THZ-98, THZ-99, THZ-100.
- 8) DLY USE CHIMP TYPE CONNECTORS FOR ELECTRICAL CONNECTIONS.
 9) DLY NOT USE WIRE NUTS OR OTHER TYPE CONNECTORS.
 10) SEAL ALL FIELD WIRING CONNECTIONS FROM MOISTURE WITH EPOXY SEAL - PACKS.
 11) USE GENERAL CONTRACTOR MUST NOTIFY THE USER TO IDENTIFY ACCEPTABLE COMBINATIONS OF INTRINSICALLY SAFE APPARATUS AND ASSOCIATED APPARATUS THAT HAVE BEEN EXAMINED AS A BODY AND ASSIGNED A SET OF PARAMETERS CALLED ENTITY PARAMETERS.
 12) THE ENTITY PARAMETERS IN THE ASSOCIATED APPARATUS CAN BE FOUND IN THE CONTROL DRAWING FOR THE INTRINSICALLY SAFE APPARATUS AND ASSOCIATED APPARATUS MUST COMPLY WITH THE FOLLOWING:
 Lo (Ω) ≤ Lo (Ω)
 L (mH) ≤ L (mH)
 C (pF) ≤ C (pF)
 Ce (pF) ≤ Ce (pF)
 Le (Ω) ≤ Le (Ω)
 Lc (Ω) ≤ Lc (Ω) + Le (Ω)
 (SEE NOTE 4).
- 13) USE MOUNTING HOLES TO SECURE TS-DTU/P TO WALL OR MOUNTING BRACKET (SUPPLIED).

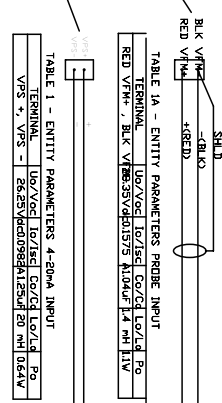

CLASS 1, DIV 2, GROUP D OR NON-HAZARDOUS LOCATION
 MODELS TS-DTU/P
 ASSOCIATED APPARATUS
 IEXX (A) IIA

TO INTRINSICALLY SAFE APPARATUS

TO TWO WIRE 4-20mA INTRINSICALLY SAFE APPARATUS

TABLE 1A - ENTITY PARAMETERS PROBE INPUT	
TERMINAL	UG/VoCI Lo/IECI Co/CE Lo/Ld Po
RED WIRE -	BLK WIRE
RED WIRE -	BLK WIRE

TABLE 1 - ENTITY PARAMETERS 4-20MA INPUT	
TERMINAL	UG/VoCI Lo/IECI Co/CE Lo/Ld Po
WIRE +, WIRE -	2825V60009881250M 20 mA 054V

INCON
 INTRINSICALLY SAFE CONTROL SYSTEMS

CONTROL DRAWING
 TS-DTU/P

000-1724

000-1724



www.franklinfueling.com

3760 Marsh Road • Madison, WI 53718, U.S.A.
Tel: +1 608 838 8786 • Fax: +1 608 838 6433
Tel: USA & Canada 1 800 225 9787 • Tel: México 001 800 738 7610

Franklin Fueling Systems GmbH
Rudolf-Diesel-Strasse 20 • 54516 Wittlich, GERMANY
Tel: +49-6571-105-380 • Fax: +49-6571-105-510

©2008 FFS 000-0080 Rev B



Thermal Printer

Model TSSP-TMPTR

Retrofit/Installation Instructions



INCON Level 1 Training Certification Required to Install the Thermal Printer

Franklin Fueling Systems • 3760 Marsh Rd. • Madison, WI 53718 USA
Tel: +1 608 838 8786 • 800 225 9787 • Fax: +1 608 838 6433 • www.franklinfueling.com



Printer Installation

The following instructions are for the addition of an internal printer or replacement of an existing printer in a T5 Series Fuel Management System.

Note: The thermal printer requires controller module firmware rev 1.5 or higher.

Included with Printer:

- Plastic Bezel
- Thermal Printer on PCB (Printed Circuit Board)
- Hardware includes:
 - (2) stand-offs
 - Mounting screws (Quantity, size and use shown in chart)

		
(4) #6	(2) #8	(2) #10
For lower 4 holes in the PCB	For top of PCB, in stand-offs	For Plastic Bezel

Note: Use only the provided hardware to mount the printer.

Installation Procedure

Warning  **Disconnect power before opening the console cover.**

1. Open the Tank Gauge front door.
2. Remove the front door's inside cover plate by unscrewing the screws located on the plate. (Number of screws vary by model).

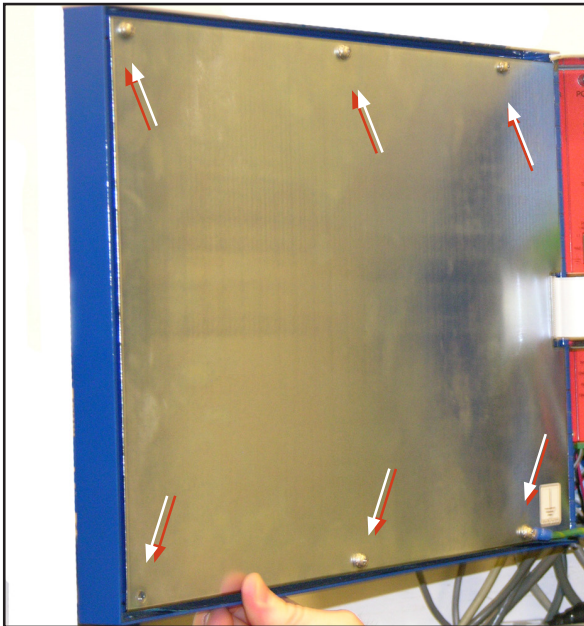

Figure 1: Remove Inside Cover Screws

To Retrofit a Printer in a Console Without One

- a. Remove the 4 nuts that secure the blank-off plate.
 - b. Remove the plate (blank-off plate may stick to the overlay).
 - c. Carefully cut out the part of the overlay that covers the printer opening using a sharp knife.
- Go to step 9.

3. Disconnect the cable that connects the impact printer to the interface board in the front door.

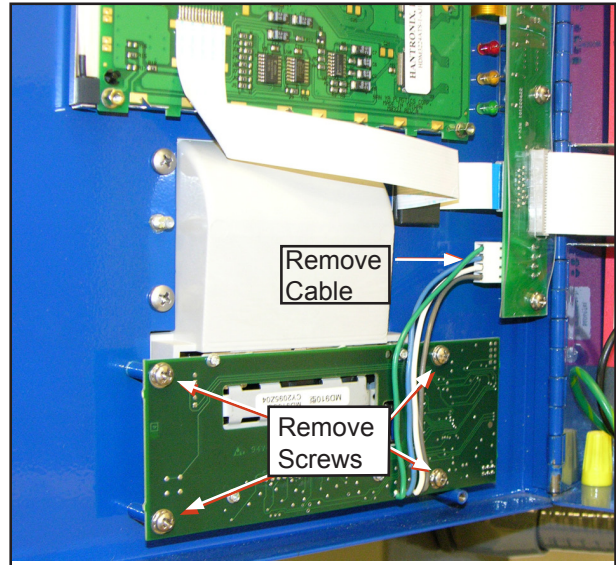

Figure 2: Disconnect Old Printer

4. Remove the roll of paper from the printer.
5. Remove the 4 screws that hold the impact printer to the front door.

Note: Be careful not to damage the ribbon cable.

6. Pull the printer gently and slowly a couple of inches away from the door. Completely remove the impact printer board.
7. Remove the 4 screws that hold the printer's plastic cover printer to the front door.

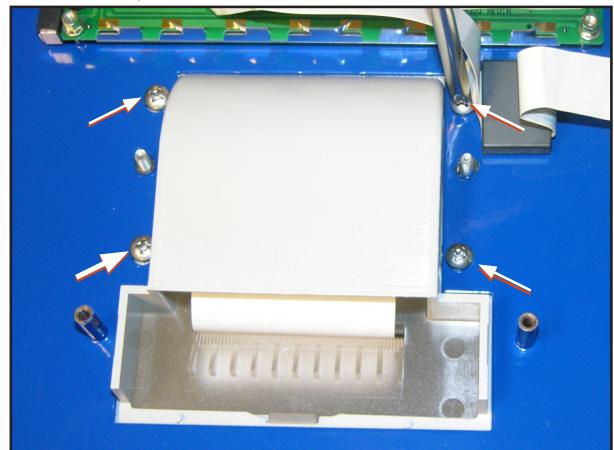

Figure 3: Remove Plastic Cover

8. Remove the plastic cover.
9. Place the new plastic bezel over the cutout in the front door. Fasten the bezel to the enclosure using the two #10 self-tapping screws supplied. Start the screws in the lower two mounting holes. Do not tighten screws all the way at this time. These screws will be tightened after installing the printer assembly.
10. Install the 2 stand-offs on the studs located next to the printer opening (Figure 4).

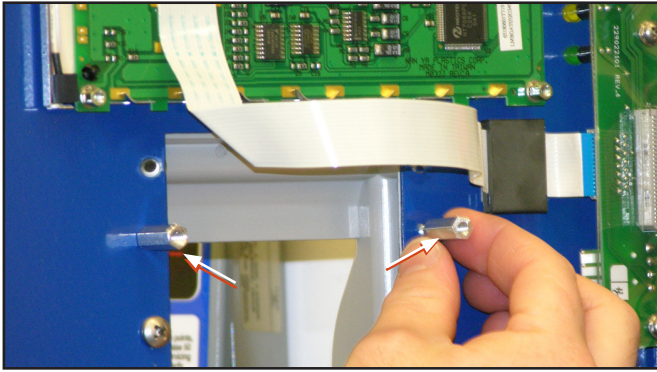

Figure 4: Install Stand-offs

11. Mount the printer so that the clear printer cover faces outward of the front door.

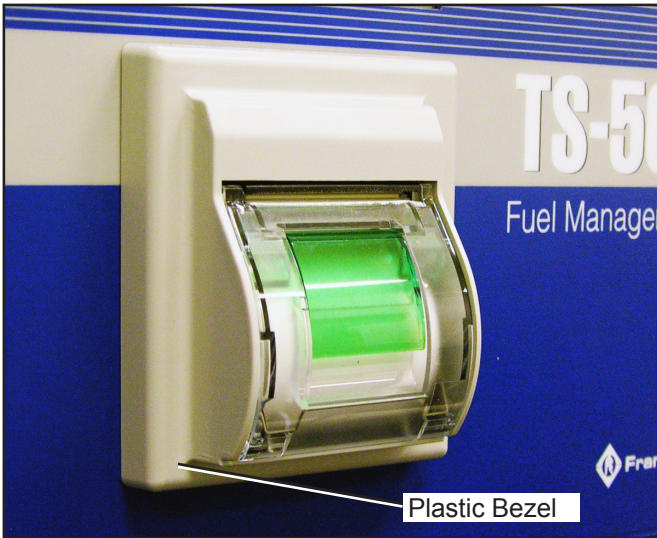

Figure 5: Mount Printer in Door

12. Attach the 6 screws for the thermal printer board to the front door (Figure 6). Refer to the screw chart on the previous page.

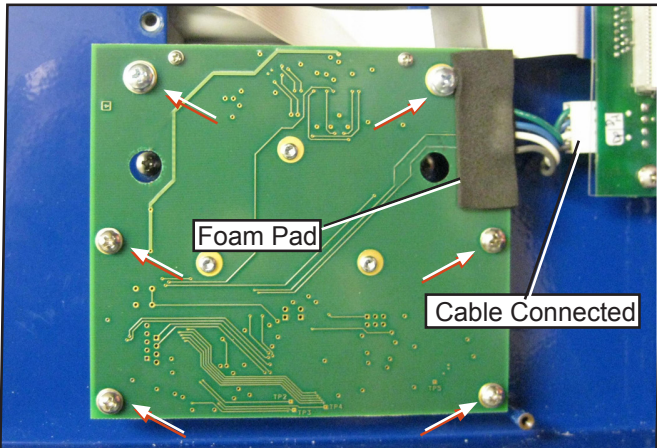

Figure 6: Printer Circuit Board Installed

13. Connect the cable from the thermal printer board to the interface board of the front door (Figure 6).
14. Tighten the two screws that hold the plastic bezel by inserting a screwdriver through the access holes in the circuit board.
15. Check to make sure the foam pad covers the corner of the circuit board where the power cables connect.

16. Replace the metal inside cover plate on the front door and fasten the screws. Make sure to reattach the ground connector to the plate.
17. Lift up on the green panel to open the printer and load paper (Figures 7-9). Make sure the roll is oriented as shown.

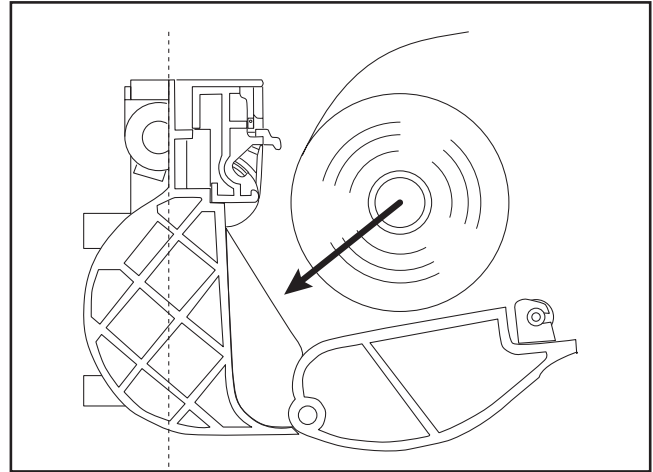

Figure 7: Load Paper



Figure 8: Do NOT load paper from door, Do NOT have paper wound loosely

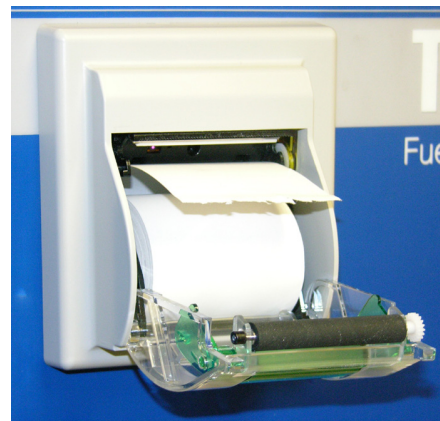

Figure 9: Paper Loaded Correctly

18. Close the printer door.
19. Restore power to the tank gauge.

Paper Specifications

Type: Thermal Printer Paper
 Width: 58 mm (2.28")
 FFS part #: TS-TP2 (box of 5 rolls)
 TS-TP2C (Carton of 20 boxes = 100 rolls)

To print a test page

1. Once the tank gauge is on, press the Main Menu key on the LCD with the figure of a table (Figure 10).

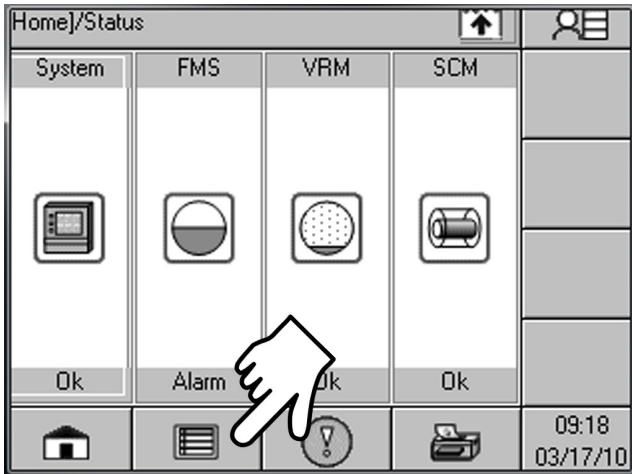

Figure 10: Select Main Menu

2. Press the arrow on the right side bar once.

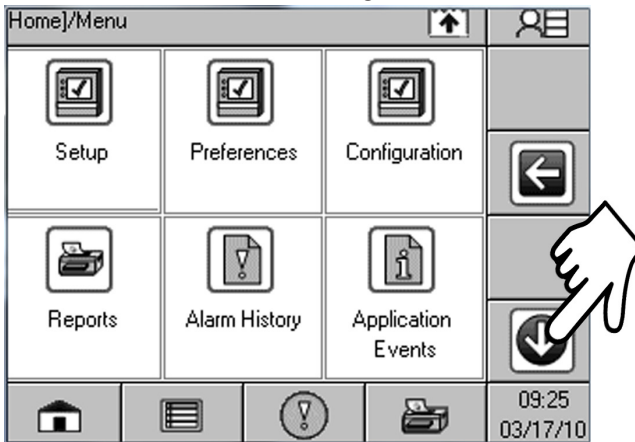

Figure 11: Select Arrow Down

3. Press **Diagnostics**.

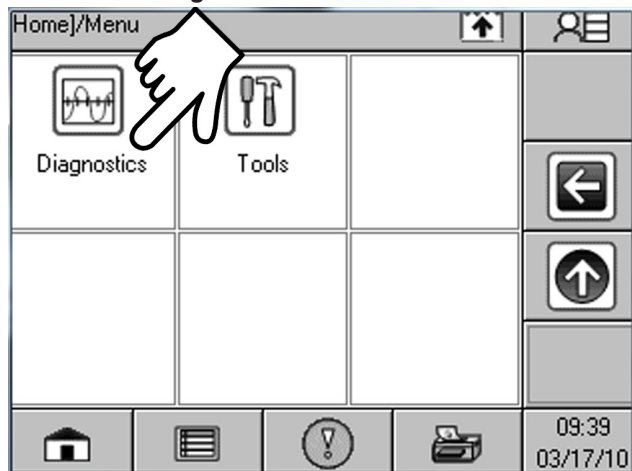

Figure 12: Select Diagnostics

4. Press **Print Test Page**.

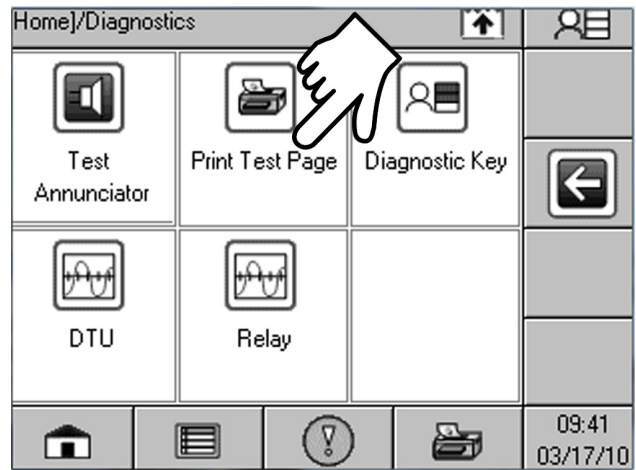

Figure 13: Print Test Page

Printer Operation Notes

- On rare occasions, when printing excessively long reports at high ambient temperature, the printer may need to pause momentarily. Printing will resume automatically after a few seconds.
- An open printer door or no-paper will generate an out-of-paper alarm.
- If you are trying to print and the paper is spooling but no text is printing, check paper roll orientation per Figure 7.
- The paper tear-bar is located at the top. Tear the paper with a lifting motion (Figure 14).

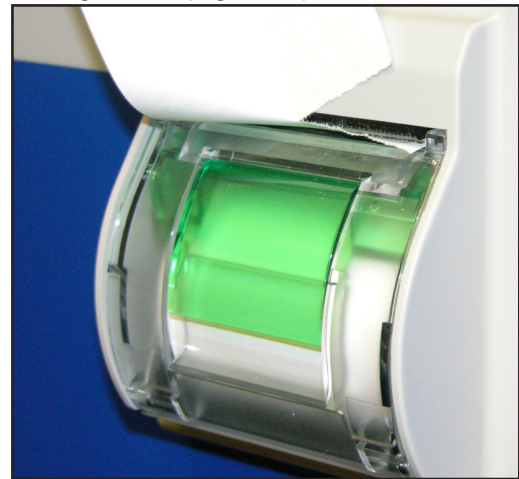

Figure 14: Tear Paper with Lifting Motion



Franklin Fueling Systems

www.franklinfueling.com

3760 Marsh Road • Madison, WI 53718, U.S.A.

Tel: +1 608 838 8786 • Fax: +1 608 838 6433

Tel: USA & Canada 1 800 225 9787 • Tel: México 001 800 738 7610

Franklin Fueling Systems GmbH

Rudolf-Diesel-Strasse 20 • 54516 Wittlich, GERMANY

Tel: +49-6571-105-380 • Fax: +49-6571-105-510