

Healy Model 8701VV Breakaway

**HEALY STAGE II VAPOR RECOVERY
PART NO. 8701VV BREAKAWAY (HOSE BREAK)
ASSEMBLY & INSTALLATION INSTRUCTIONS**

- The Healy Breakaway is delivered loosely assembled. Handle carefully to avoid dropping and/or losing the precision parts.
- Failure to remove the Shear screw (Item 1) as described in Step 1 below could result in fracturing or shearing of the screw. The Shear screw will require replacement if damaged.
- Be sure to assemble parts in the exact sequence as shown below.
- Be sure to lubricate all o-rings and quad seals where indicated. Use of ordinary motor oil is sufficient.
- Do not use thread-sealing compounds on straight threads.

ASSEMBLY INSTRUCTIONS
(refer to diagram at right)

1. Remove the Shear Screw (Item 1) and the packing materials. Separate the halves of the breakaway assembly, retaining the loose internal valves, (Items 2 & 3) and the spring (Item 13) inside the upper half.
2. Select the pigtail, (whip hose) assembly. Lubricate the quad and o-ring seals (Items 4, 5, 8, & straight thread, Item 6). Assemble the pigtail to the input half of the Breakaway (Item 7) being sure that the larger end of the conical spring is centered in the groove on the white valve. Tighten hose to Breakaway at 35 to 70 foot pounds. Be sure the vapor tube fitting slides easily into item 2 before final tightening.
3. Select the delivery hose, lubricate the o-ring (Item 4), the quad seal (Item 5) and straight thread (Item 6). Assemble the end with the quad seal to the output half of the Breakaway (Item 10), install the secondary hose and tighten to 35 to 70 foot pounds. Be sure the vapor tube fitting slides easily into item 3 before final tightening.
4. Carefully fit both halves of the Breakaway together. Utilizing the alignment pin, fully compress both halves and insert the Shear Screw (Item 1) and hand tighten. Final tighten to 20 inch pounds. Tools should not be necessary to initially start the screws.

14	2	1-117	O-RING, PRECISION #8727	708
13	1	A8701-752	SPRING, CONICAL	752
12	1	1-122	O-RING, PRECISION #8727	709
11	2	78-312	O-RING, PRECISION #8727	75414
10	1	CB701-750-2	BODY, NOZZLE END	750-2
8	2	1-012	O-RING, PRECISION #5747	291
7	1	CB701-748	BODY, DISPENSER END	748
6	2		HOSE FITTING	
5	4	4012	QUAD-RING S14GJ	HB4
4	4	1-025	O-RING, PRECISION #5747	HB2
3	1	BB701-781	VALVE, NOZZLE END	781
2	1	BB701-748	VALVE, DISPENSER END	748
1	2	BB701-716	SHEAR, SCR.	787
ITEM NO.	QTY	DWG NO.	DESCRIPTION	P/N

LIST OF MATERIAL

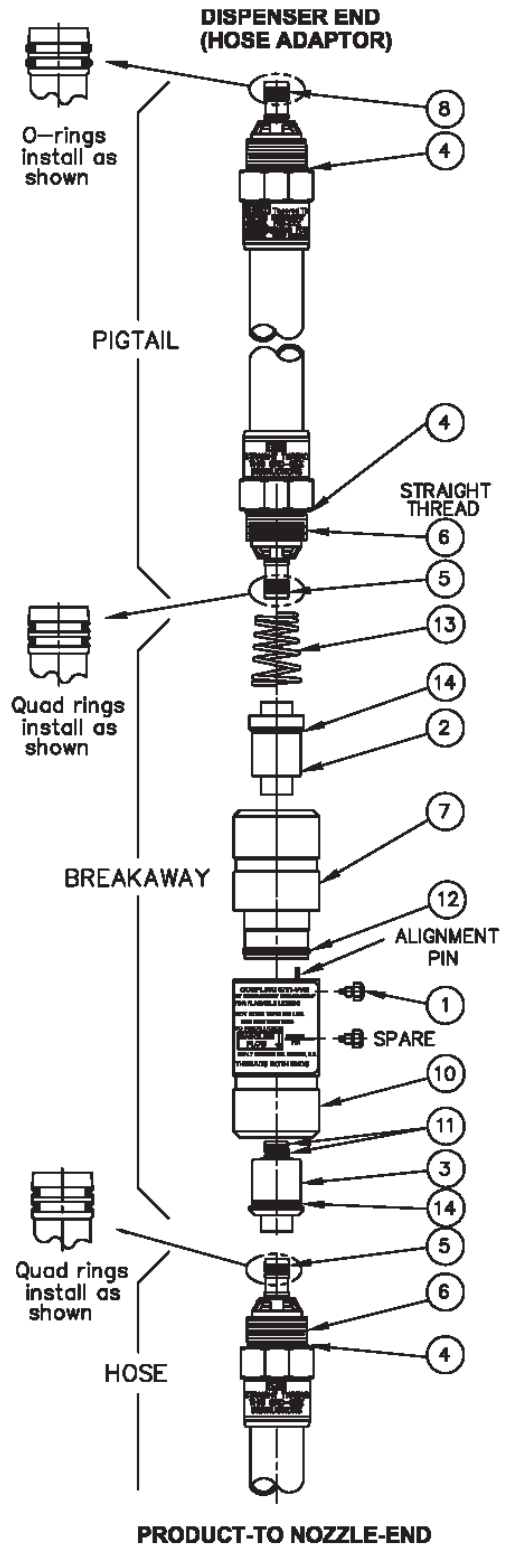

DRIVE-OFF BREAKAWAY RECONNECTION PROCEDURE

Use this procedure to either reconnect or disconnect (reverse order) the Healy 8701VV Breakaway as part of Section 1.4 Procedure for Reconnecting Breakaway and Testing Fueling Point after Drive-Off in the Assist Systems Scheduled Maintenance.

NOTE: Breakaway Reconnections must be logged in the GDF Maintenance Log.

Reconnection Procedure Option

I. HEALY BREAKAWAY RECONNECTION CLAMP	1
II. EASYGRIP RECONNECTION TOOL	3

I. HEALY BREAKAWAY RECONNECTION CLAMP

TOOLS NEEDED:

- Healy Breakaway Reconnection Clamp, Part No. 795
- 8mm Hex Head Socket
- Torque wrench
- Safety glasses

RECONNECTION PROCEDURE

1. Inspect each half of the separated breakaway for obvious damage to the outer-shell, plastic inserts or o-rings; including cracks, chips or tears that may effect reconnecting the two halves.
2. Check the shear pin bushing hole (see Figure 2) located in the top half of the breakaway for any part of the pin left behind at separation. A gentle tap on the opposite side of the breakaway should eject the pin.
3. After completing inspection, lightly lubricate the main o-ring on the top half of the breakaway. Any weight motor oil is acceptable.
4. Slide the top clamp of the Breakaway Reconnection Clamp onto the two flat surfaces on the top half of the breakaway (See Figure 1) installed on the dispenser (attached to whip hose).
5. Slide the separated bottom half of the breakaway (with hose and nozzle attached) onto the bottom clamp of the Breakaway Reconnection Clamp and begin squeezing the grip to slowly bring the two halves together. Check the main o-ring for position as the top and bottom of the breakaway come together.
6. Align the dowel pin in the bottom half of the breakaway with the dowel pin guide located in the

top half of the breakaway. When dowel pin and guide are aligned, continue squeezing tool grip until the breakaway halves join together.

CAUTION: Reconnection can cause a small amount of gasoline to leak out of the breakaway. A towel wrapped loosely around the breakaway can help to minimize fuel spills.

7. Remove the shear pin (#787) located in the spare shear pin location of the breakaway and install in place of the original.
8. Torque the shear pin to 20 inch-pounds (~ 1.5 ft-lbs). **DO NOT OVER-TIGHTEN.**
9. If available, install a shear pin (#787) in the spare shear pin location.
10. Remove the Breakaway Reconnection Clamp.
11. Proceed with the tests outlined in Section 1.4 of the Healy Systems Scheduled Maintenance.

Figure 1

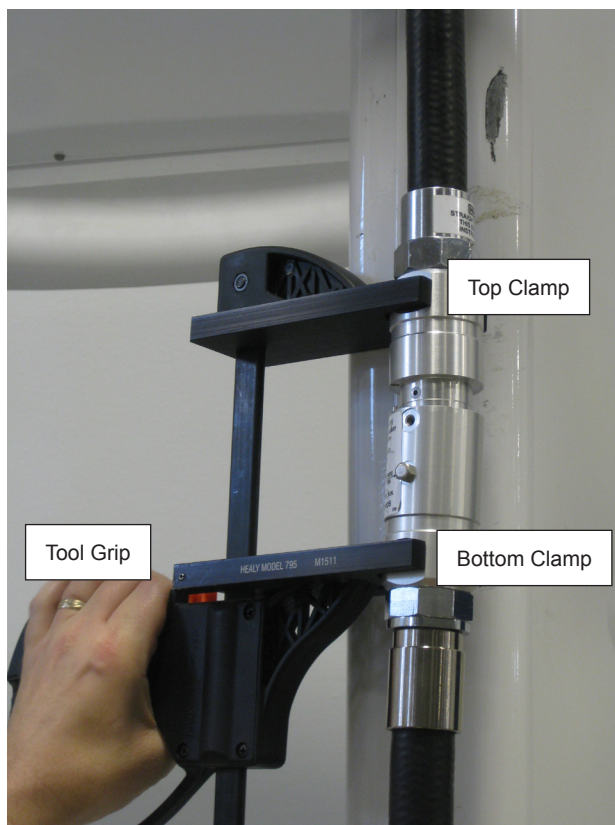

Figure 2



Franklin Fueling Systems
3760 Marsh Road
Madison, Wisconsin 53718 USA
ARB Approved Installation, Operation and Maintenance Manual

Website: <http://www.franklinfueling.com>
Email: sales@franklinfueling.com
Telephone: 800-225-9787
Fax: 608-838-6433



II. EASYGRIP BREAKAWAY RECONNECTION CLAMP

TOOLS NEEDED:

- EasyGrip Reconnection Clamp

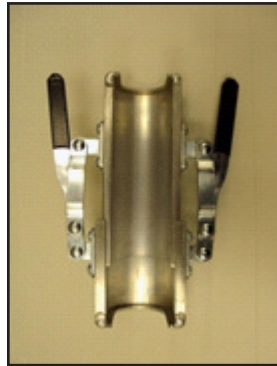

- 8 mm Hex Head Socket
- Torque wrench
- Safety Glasses

RECONNECTION PROCEDURE

NOTE: Additional information on the EasyGrip operation can be found by viewing a video clip on their website at <http://www.simplegrip123.com/>

1. Inspect each half of the separated breakaway for obvious damage to the outer-shell, plastic inserts or o-rings; including cracks, chips or tears that may effect reconnecting the two halves.
2. Check the shear pin bushing hole, (See Figure 1) located in the top half of the breakaway for any part of the pin left behind at separation. A gentle tap on the opposite side of the breakaway should eject the pin.



Figure 1

3. After completing inspection, lightly lubricate the main o-ring on the top half of the breakaway (See Figure 1). Any weight motor oil is acceptable.
4. With the EasyGrip in its full open position, place the top portion of the breakaway into the top side of the EasyGrip and the bottom portion of the breakaway into the bottom side (See Figure 2).



Figure 2

5. Pull the two handles of the Easy Grip down at the same rate to slowly bring the two halves together. Check the main o-ring for position as the top and bottom of the breakaway come together. See Figure 3.

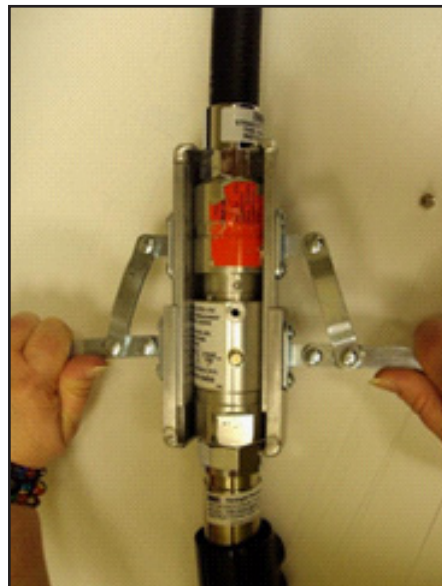

Figure 3

6. Align the dowel pin in the bottom half of the breakaway with the dowel pin guide located in the top half of the breakaway. When the dowel pin and guide are aligned, continue squeezing tool grips until the breakaway halves come together. See Figure 4

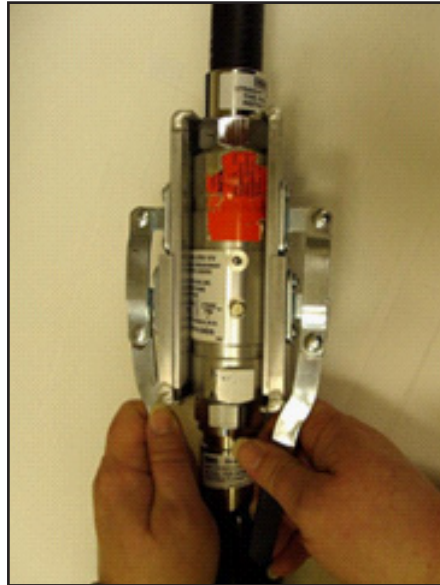

Figure 4

CAUTION: Reconnection can cause a small amount of gasoline to leak out of the breakaway. A towel placed in front of the reconnection zone of the breakaway can help to minimize fuel spills.

7. Remove the shear pin (#787) located in the spare shear pin location of the breakaway and install in place of the original. See Figure 5



Figure 5

8. Torque the shear pin to 20 inch-pounds (~ 1.5 ft-lbs).
DO NOT OVER-TIGHTEN
9. If available, install a shear pin (#787) in the spare shear pin location.
10. Remove the Easygrip.
11. Proceed with the tests outlined in Section 1.4 of the Healy Systems Scheduled Maintenance.

Healy Model 807 Swivel Breakaway

IMPORTANT: This sheet must be left with service station manager.

**HEALY STAGE II VAPOR RECOVERY MODEL
807 SWIVEL BREAKAWAY (HOSE BREAK)
ASSEMBLY & INSTALLATION INSTRUCTIONS**

- The Healy Swivel Breakaway is delivered loosely assembled. Handle carefully to avoid dropping and/or losing the precision parts.
- Failure to remove the Shear screw (Item 9) as described in Step 1 below could result in fracturing or shearing of the screw. The Shear screw will require replacement if damaged.
- Be sure to assemble parts in the exact sequence as shown below.
- Be sure to lubricate all o-rings and quad seals where indicated. Use of ordinary motor oil is sufficient.
- Do not use thread-sealing compounds on straight threads.
- This Breakaway shall be installed between the product hose and the nozzle end (threaded onto nozzle).

ASSEMBLY INSTRUCTIONS
(refer to diagram at right)

1. Remove the Shear Screw (Item 9) and the packing materials. Separate the halves of the breakaway assembly, retaining the loose internal valve, (Item 6) and the spring (Item 11) inside the halves.
2. Install the male threaded half of the 807 into the Healy Nozzle. Lubricate the o-ring seals (Items 17 & 21) and tighten to 35 to 70 foot pounds. Be sure the vapor tube fitting slides easily into the nozzle before final tightening.
3. Select the delivery hose, lubricate the o-ring seals and straight thread. Assemble the non-swivel end of the Breakaway on the hose. Tighten to 35 to 70 foot pounds. Be sure the valve and spring (items 6 & 11) are in place before final tightening.
4. Carefully fit both halves of the Breakaway together. Utilizing the alignment pin, fully compress both halves and insert the Shear Screw (Item 9) and hand tighten. Final tighten to 20 inch pounds. Tools should not be necessary to initially start the screws.

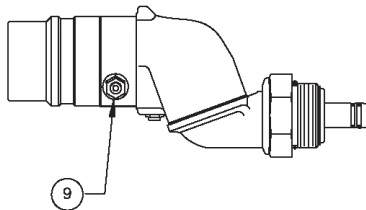

NOTE: SHEAR SCREW INSTALLS 45° FROM SPARE.

NOZZLE END

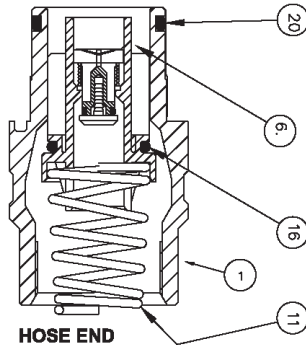
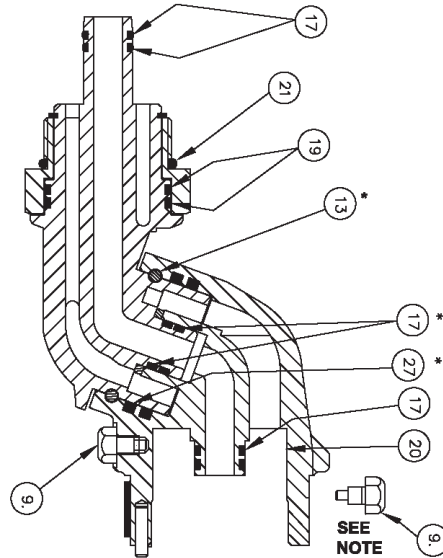

* NOT FIELD REPLACEABLE

*	27	2	4125-514GJ	QUAD RING, MINNISOTA RUBBER	80727
	21	1	1-025	O-RING, PRECISION #5747	HB-2
	20	1	1-122	O-RING, PRECISION #9727	709
	19	2	1-024	O-RING, PRECISION #5747	MPD-5
	18	1	1-117	O-RING, PRECISION #9727	70B
*	17	6	1-012	O-RING, PRECISION #5747	75414
	16	1	1-009	O-RING, PRECISION #9727	753
	11	1	A8701-752	SPRING, CONICAL	752
	9	2	BB701-787	SCREW, SHEAR	787-1
	6	1	A8701-748	VALVE, DISPENSING END	748
	4	1	BB701-810	BUSHING	810
	2	1	C8701-805	SWIVEL, FEMALE, (MACHINED)	805
	1	1	C8701-809	BODY, DISPENSER END	809
	ITEM NO.	QTY	DWG NO.	DESCRIPTION	P/N

LIST OF MATERIAL

HEALY SYSTEMS, INC.

18 Hampshire Drive * Hudson, New Hampshire 03051
(603) 882-2472 Telephone* (603) 882-5189 FAX

healy
... the SMART Stage II solution

A8701-807-INST-M
11/15/06 REV. M

DRIVE-OFF BREAKAWAY RECONNECTION PROCEDURE

Use this procedure to either reconnect or disconnect (reverse order) the Healy 807 Swivel Breakaway as part of Section 1.4 Procedure for Reconnecting Breakaway and Testing Fueling Point after Drive-Off in the Healy Systems Scheduled Maintenance.

TOOLS NEEDED:

- Healy Breakaway Reconnection Clamp, Part No. 795
- 8mm Hex Head Socket
- Torque wrench
- Safety glasses

1. Inspect each half of the separated breakaway for obvious damage to the outer-shell, plastic insert or o-rings; including cracks, chips or tears that may effect reconnecting the two halves.
2. Check the shear pin bushing hole (see Figure 3) located in the half of the breakaway attached to the hose for any part of the pin left behind at separation. A gentle tap on the opposite side of the breakaway should eject the pin.
3. After completing inspection, lightly lubricate the main o-ring on the half of the breakaway that's attached to the hose and the two small o-rings inside the half of the breakaway attached to the nozzle. Any weight motor oil is acceptable.
4. Remove the black handle cover from the nozzle (See Figure 1).
5. Slide the top clamp of the Breakaway Reconnection Clamp above the two flat surfaces on the nozzle (See Figure 2).
6. Slide the half of the breakaway that's attached to the hose onto the bottom clamp of the Breakaway Reconnection Clamp and begin squeezing the grip to slowly bring the two halves together. Check the main o-ring for position as the top and bottom of the breakaway join together (See Figure 2).
7. Align the dowel pin in the top half of the breakaway with the dowel pin guide located in the bottom half of the breakaway (See Figure 3). When dowel pin and guide are aligned, continue squeezing tool grip until the breakaway halves come together (See Figure 4).

Caution: Reconnection can cause a small amount of gasoline to leak out of the breakaway. A towel wrapped loosely around the breakaway can help to minimize fuel spills.

7. Remove the shear pin (#787-1) located in the spare shear pin location of the breakaway and install in place of the original.
8. Torque the shear pin to 20 inch-pounds (~ 1.5 ft-lbs). **DO NOT OVER-TIGHTEN.**
9. If available, install a shear pin (#787-1) in the spare shear pin location.
10. Remove the Breakaway Reconnection Clamp.
11. Proceed with the tests outlined in Section 1.4 of the Healy Systems Scheduled Maintenance.

Figure 1



Figure 2

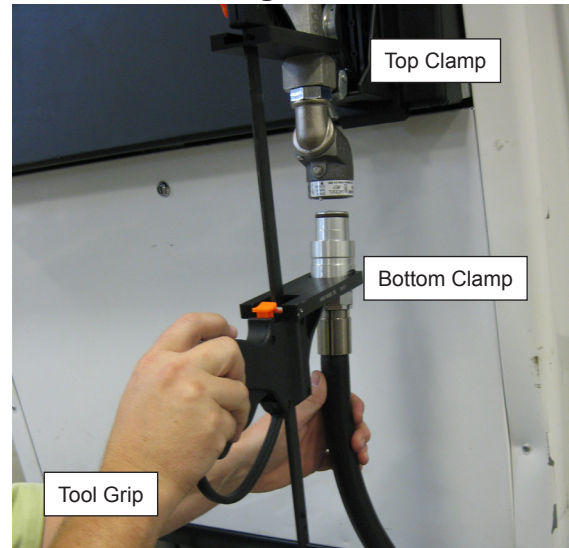

Figure 3

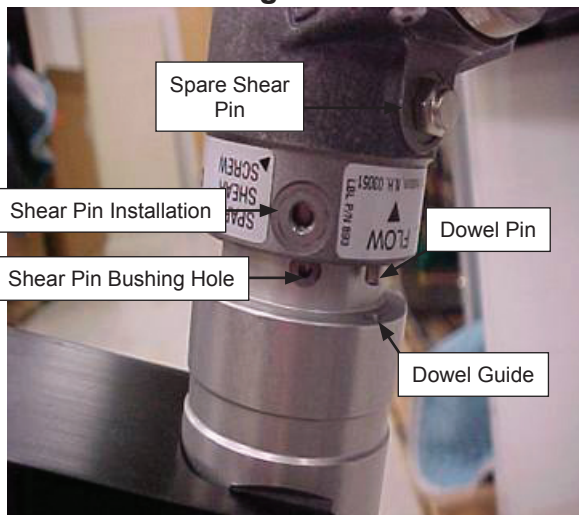
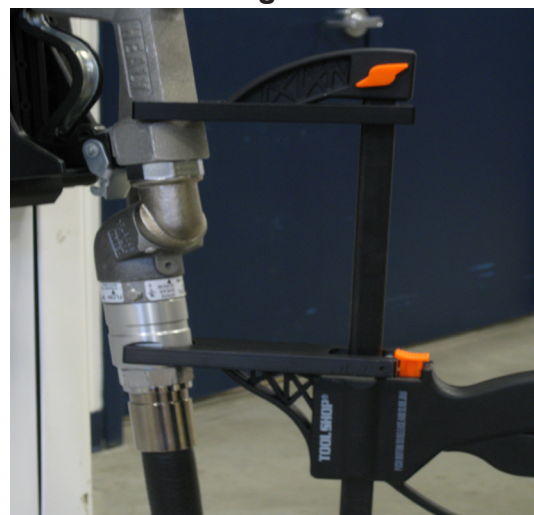

Figure 4



Franklin Fueling Systems
3760 Marsh Road
Madison, Wisconsin 53718 USA
ARB Approved Installation, Operation and Maintenance Manual

Website: <http://www.franklinfueling.com>
Email: sales@franklinfueling.com
Telephone: 800-225-9787
Fax: 608-838-6433



Franklin Fueling Systems





Recommended Instructions Installation, Maintenance, Inspection

CATLOW CTMCA Breakaway

577014-071
DATE 12/2013

VERY IMPORTANT READ THIS BEFORE INSTALLING YOUR BREAKAWAY



**WARNING: USE ONLY ON SYSTEMS RATED AT 50 PSI MAXIMUM
USE ON SYSTEMS HAVING HIGHER STATIC PRESSURE MAY CAUSE PREMATURE SEPARATION**

**ALWAYS CHECK FOR ELECTRICAL CONTINUITY FOLLOWING PETROLEUM EQUIPMENT INSTITUTE
(PEI) RECOMMENDED TEST PROCEDURE (PEI/RP400-02)**

PRIOR TO INSTALLATION: Refer to the model of breakaway for the maximum pull force before you proceed with the instructions

Caution must be used when testing to prevent damage to the dispenser or personal injury.

ALL DISPENSERS MUST BE BOLTED TO THE ISLAND. (NFPA 30A 6.3.4 and PEI/RP500-11 2.2)

CONFIRM DISPENSER IS SECURE.

- Attach a spring scale to the dispenser where the breakaway will be installed.
- Apply a 350 lbs pull force at various angles and check the emergency valves, Dispenser and hose assembly. (UL STANDARD 567)
- Release the load and complete the installation of the breakaway.

CTMCA INSTALLATION KIT - P/N 4037

Qty.	P/N	Description
1 ea.	CTMCA	Cam Twist Magnetic Breakaway
2 ea.	M3418	CTMCA Hose Adapter

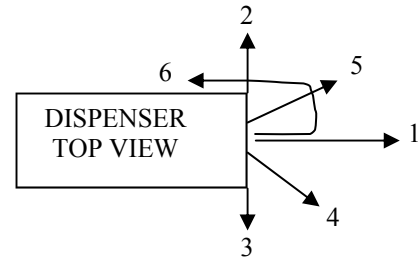

INSTALLATION NOTES

- The CATLOW in-line breakaway must always be installed between two hose sections (example: whip & main hose)
- On side hose connections install the breakaway between the nozzle and the hose retractor (NFPA 30A 6.5.3)
DO NOT INSTALL THE BREAKAWAY ON THE DISPENSER SIDE OF THE HOSE RETRACTOR
- On an overhead hose connection, install the short section of whip hose then the breakaway, hose and nozzle

INSTALLATION INSTRUCTIONS FOR THE CTMCA BREAKAWAY

NOTE: Catlow recommends using a swivel end hose in proximity to the CAM TWIST

1. Isolate/turn the dispenser OFF and relieve the line pressure from the system by opening the nozzle and allowing the system to drain into an approved metal container.
2. Observe the flow direction arrow on the breakaway and install with the flow arrows pointing towards the nozzle
3. Use thread sealant recommended by UL for petroleum products on pipe thread connections
4. Use oil or grease on straight or metric thread o-ring fittings **DO NOT USE TEFLON TAPE**
5. If the M3418 Ferrule is damaged and must be replaced, install M3418 on CTMCA and tighten to 90 lbs/ft torque.
 CAUTION: Applying torque simultaneously to both ends of the breakaway may cause the breakaway to separate or damage the anti-rotation pins
6. Activate/turn the dispenser ON and purge the hoses and nozzles of air into an approved metal container
7. Check the system for leaks, replace any item that exhibit signs of leakage

Hoses should not be long enough that a vehicle could drive over the hose resulting in a direct pull on the retractor cable or dispenser and bypass the breakaway



When Replacing CTMCA Ensure M3418 Ferrule Stays With Hose And Does Not Get Discarded Along With Discarded CTMCA



Use Only UL Listed Paste Type Thread Sealant



Always Refer To Your Local City, State Or Federal Testing Regulations



Recommended Instructions

577014-071
DATE 12/2013

CAM TWIST MAGNETIC BREAKAWAY

Model: CTMCA

IF SEPARATION OCCURS

1. Isolate/turn off dispenser, relieve line pressure from the whip hose and the nozzle hose. Drain fuel into an approved metal container.
2. Inspect the entire system for damage and/or leaks. Replace any damaged components in the system (*PEI/RP500-11 9.2.2*).
3. **Clean the magnet surfaces** on both the male and female couplings and inspect for damage.
4. Replace damaged o-rings using CATLOW repair kit.
Lubricate the o-rings and the mating male and female surfaces with oil or grease.
- 4a On Model CTMCA, O-rings must be replaced using CATLOW repair kit P.N.#2977.
5. Align the flow arrows and push the halves together engaging the coupling mechanism until a noticeable snap is felt indicating the unit is properly reconnected.
6. Test the reconnection by pulling on the hose just below the breakaway.
7. Activate/turn on the dispenser and purge the hose and nozzle of air into an approved metal container.
8. With the system pressurized, check for leaks around the breakaway, nozzle, both hoses and all joints.
9. Replace any item that exhibit signs of leakage.

Isolate fuel pressure/flow from the system. If dispenser is off and depressurized, o-rings can be safely replaced WITHOUT draining the hose assembly. Always lubricate o-rings before installing and reconnecting. An o-ring pick or small stiff wire will be useful to remove old o-rings.

CTMCA O-RING REPLACEMENT

The CTMCA has three (3) O-rings that can be serviced or replaced in the field. These are used to seal fuel, vapor and dirt. **To Replace these O-rings use CATLOW PN #2977**



SEPARATES IN ONE DIRECTION ONLY

Use two open end wrenches and apply in a clockwise rotary torque



VAPOR VAPOR VAPOR VAPOR

The Vapor o-ring is the smallest o-ring in the repair kit. It is located in the upper section of the breakaway. This will need to be replaced if meter creep is observed.



DIRT DIRT DIRT DIRT

The largest o-ring is used to keep dirt out of the nylon covers and breakaway assembly. Replace if missing or damaged.



LIQUID LIQUID LIQUID LIQUID

Occasionally during a drive-off or reconnection, the liquid o-ring gets pinched or cut. If a breakaway leaks after reconnection, replace the liquid o-ring. Reach inside the lower section of the breakaway, squeeze the o-ring and remove it.



ALWAYS LUBRICATE WITH OIL OR GREASE BEFORE RECONNECTION



REPAIR KIT

PN	DESCRIPTION
2977	Repair Kit CTMVA/CTMCA



CATLOW products should be used in compliance with applicable federal, state and local laws and regulations. Product selection should be based on physical specifications and limitations and compatibility with the environment and material to be handled.

EQUIPMENT WARRANTY

Veeder-Root warrants that this product shall be free from defects in material and workmanship and is compliant with all applicable performance standards and specifications for which it has been certified, for a period of one (1) year from date of installation when proof of the date of install is provided. Or fifteen (15) months from date of manufacture (see terms below) when proof of date of installation is not provided.

Date of manufacture: _____

*Product S/N: _____

*Date of installation: _____

*Technician number: _____

Required Information**Installation Address:**

Street: _____

City: _____ State: _____

Phone: _____ - _____ - _____

This component was tested at the time of manufacture and meets all the applicable performance standards and specification to which it was certified: E.O. VR-201 and VR-202.

For detailed warranty terms see EO warranty exhibits (VR-201/VR-202 Exhibit 6) on the ARB Web site at:
<http://www.arb.ca.gov/vapor/eo-evrphasell.htm>

VST Installation Procedure for Phase II EVR Vacuum Assist Safety Breakaway Devices

Part Number Series:
VST-HEVR-SBK;
VST-ISVR-SBK



Vapor Systems Technologies, Inc.
650 Pleasant Valley Drive
Springboro, Ohio 45066 (USA)

Toll Free: 1-888-878-4673
Phone: 937-704-9333
Fax: 937-704-9443
www.vsthose.com

APPLICATION

These VST Safety Breakaway devices are intended to prevent damage to the dispenser and hose in the event of a vehicle drive off. These devices separate at pull forces up to 350 lbs. You will need to determine that 350 lbs. of pull force will not damage the dispenser.

After verifying that the dispenser is securely bolted to the island, it can be tested by using a spring scale and a length of rope. The rope must be connected at the dispenser outlet casting, which may require a threaded bushing with a hole for attaching the rope. Attach the scale to the rope and pull to 350 lbs. in several directions. Be sure to avoid damaging the dispenser.

NOTE

- The whip hose **ALWAYS** attaches to the dispenser. If a retractor is being used, the retractor clamp **MUST** be between the breakaway and dispenser.
- VST hoses are made to withstand 350 pounds tensile pull without damage. If another brand of hose is present at the dispenser, VST recommends that you contact the hose manufacturer regarding the compatibility with this breakaway device.

GENERAL INFORMATION

If hanging hardware components are involved in a drive-off or incur other customer abuse, each individual component must be functionally tested prior to customer dispensing activities.

INSTALLATION PREPARATION

These procedures must be followed to ensure leak-proof installation and operation of these safety breakaway products.

- Turn off and tag the power to the dispenser. Dispenser must be de-energized prior to service to avoid personal injury.
- Barricade work area to block vehicle access to the dispenser.
- Close dispenser shear valve prior to performing any service work with the hanging hardware (hoses, safety breakaways, and nozzles).
- Drain liquid product from the hanging hardware set into an approved container prior to replacing any hanging hardware component.
- When not using the VST Breakaway Assembly Tool (VST-BAT-200), remove hanging hardware from the dispenser prior to making replacement component assembly connections. VST recommends connecting the whip hose to dispenser as the last connection during hanging hardware assembly.

INSTALLATION AND FUNCTION TESTS

- Initial inspection:
 - Carefully unpack safety breakaway from shipping carton.
 - Inspect safety breakaway for any damage to threads, O-rings, exterior, etc.
- Lightly lubricate **ALL** O-rings on mating connections with petroleum jelly or other suitable lubricant. **DO NOT USE** pipe dope or thread sealant.
- Attach breakaway on mating connection and tighten by hand. **NOTE FLOW DIRECTION ARROW** (where applicable). Use the hex on the breakaway body to tighten. **DO NOT USE** the breakaway body to tighten the unit.

Figure 1.

EVR Vacuum Assist Hanging Hardware

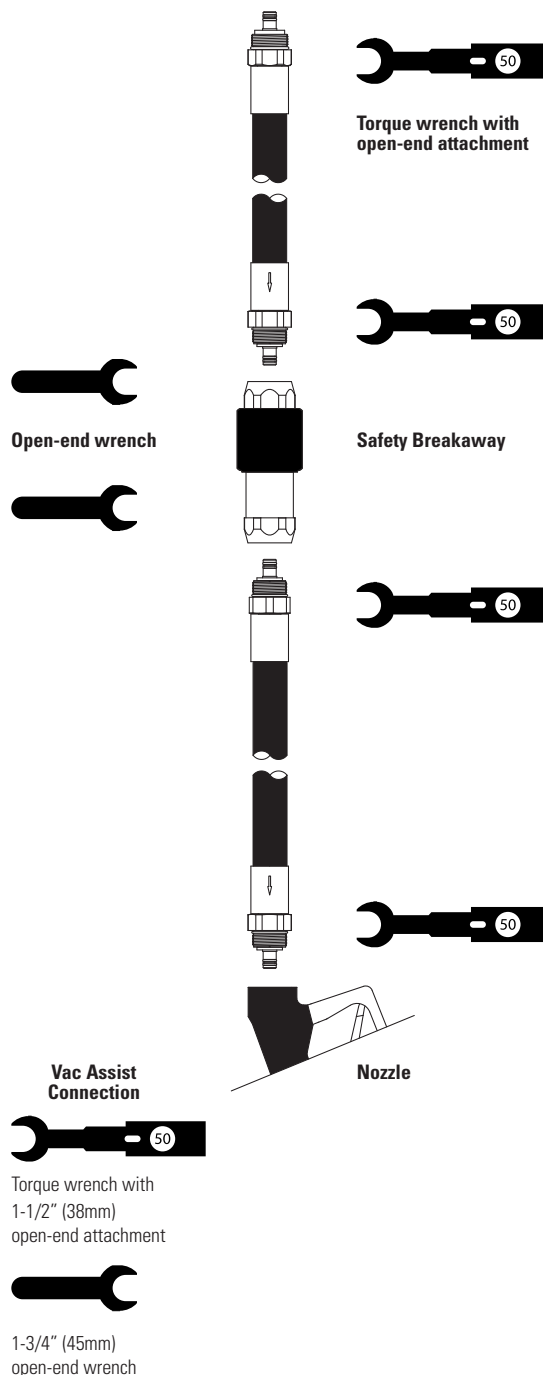

VST Installation Procedure for Phase II EVR Vacuum Assist Safety Breakaway Devices

Part Number Series:

VST-HEVR-SBK;

VST-ISVR-SBK

4. Tighten breakaway connection to 50 ft.-lbs. of torque. **DO NOT OVER TIGHTEN.** Use the hex on the breakaway body to tighten. Use a torque wrench with an open-end attachment to fit the hose couplings and an open-end wrench to properly tighten breakaway connections. **DO NOT USE** channel-locks or pliers to tighten connections. Proper ft.-lb. torque may not be achieved with these tools.
5. Purge air from the system by pumping one-tenth (1/10) to two tenths (2/10) of a gallon of fuel into an approved container. Inspect each breakaway joint connection for liquid leaks and meter creep. Make proper adjustments at the breakaway connection if necessary.
6. Check the nozzle shut-off action by dispensing fuel into an approved container at least three times to assure proper automatic operation. To test, operate the nozzle and submerge the spout tip in fuel until the fuel level covers the vent hole. The main valve of the nozzle automatically shuts off when liquid covers the vent hole at the end of the spout. The dispenser should deliver a minimum of 3 gpm. Hold open latch will disengage automatically when liquid covers the vent hole in the spout.

Figure 2.

VST Breakaway Assembly Tool



7. Measure the resistance between the dispenser outlet casting and the tip of the nozzle spout. Use an electronic multimeter set on the high range of the ohmmeter function. Resistance should not indicate more than 70,000 ohms per foot of hose. Example: The measured resistance for a 12-foot hose must not exceed 840,000 ohms (840 kilohms).

BREAKAWAY REATTACHMENT PROCEDURES

These VST reattachable breakaways can be reconnected in either one of two methods:

METHOD 1: Use of the VST Breakaway Assembly Tool (VST-BAT-200) with the appropriate reassembly plates for this breakaway.

1. Follow **INSTALLATION PREPARATION** steps 1 - 3.
2. Inspect both safety breakaway halves for damage that may have occurred during separation. Include looking for external damage to the product, damaged threads, damaged O-rings, missing O-rings, proper placement of O-rings, etc. **If damage is detected, replace with new product.**
3. Prior to reassembling, be sure the mating parts are undamaged and clean.
4. Lightly lubricate **ALL** O-rings on mating connections with petroleum jelly or other suitable lubricant.
5. Utilize the VST Breakaway Assembly Tool with the appropriate reassembly plates to reassemble the breakaway. The tool is used to provide appropriate leverage for the ease of reassembly of the breakaway. This can be done without disassembling the hoses from the breakaway halves. **See Figure 2.**
6. Press the button on the VST Breakaway Assembly Tool to spread the end clamps apart. This will allow for the two separated breakaway halves to fit between the top and bottom clamps.
7. Slide the top clamp of the VST Breakaway Assembly Tool behind the hex on the breakaway half still connected to the whip hose. **See Figure 2.**
8. Slide the separated bottom half of the breakaway, with curb hose and nozzle attached, onto the bottom clamp of the VST Breakaway Assembly Tool. **See Figure 2.**
9. Slowly squeeze the VST Breakaway Assembly Tool trigger to bring the breakaway halves together.
10. Carefully align the two breakaway halves.
 - a. Align the anti-rotation studs (2) inside the breakaway half on the curb hose with the slots (2) on the other half of the breakaway attached to the whip hose. **See Figure 3.**
11. Continue squeezing the VST Breakaway Assembly Tool trigger to finish reassembly.
12. The two aligned breakaway halves need to be assembled concentrically (properly aligned) until they snap into place.
 - a. Listen for a “click” to indicate that the two halves have been properly reattached.
 - b. If the two breakaway halves become cocked (misaligned) or otherwise do not snap together easily, pull them apart and repeat steps 7 - 12.

CAUTION: Reconnection can cause a small amount of gasoline to leak out of the breakaway. A towel wrapped loosely around the breakaway can help to minimize spills.

VST Installation Procedure for Phase II EVR Vacuum Assist Safety Breakaway Devices

Part Number Series:

VST-HEVR-SBK;

VST-ISVR-SBK

13. After the two breakaway halves are properly snapped together, remove the VST Breakaway Assembly Tool (press the button on the tool to allow it to release), and give the reassembled breakaway a strong pull to verify that it is properly connected.
14. Perform Section 1.4 – Procedure for Operator Reconnection of Breakaway and Testing Fueling Point after a Drive-Off in the Assist Systems Scheduled Maintenance.

METHOD 2: Without the use of the VST Breakaway Assembly Tool.

1. Follow **INSTALLATION PREPARATION** steps 1 - 5.
2. Disconnect hoses from the safety breakaway halves.
3. Inspect both safety breakaway halves for damage that may have occurred during separation. Include looking for external damage to the product, damaged threads, damaged O-rings, missing O-rings, proper placement of O-rings, etc. **If damage is detected, replace with new product.**
4. Prior to reassembling, be sure the mating parts are undamaged and clean.

Figure 3.

Anti-Rotation Studs and Slots



5. Lightly lubricate **ALL** O-rings on mating connections with petroleum jelly or other suitable lubricant.
6. Carefully align the 2 breakaway halves.
 - a. Align the anti-rotation studs inside the breakaway half on the curb hose with the slots on the other half of the breakaway -inside the breakaway half on the whip hose. **See Figure 3.**
7. The two aligned breakaway halves need to be assembled concentrically (properly aligned) until they snap into place.
 - a. Listen for a “click” to indicate that the two halves have been properly reattached.
 - b. If the two breakaway halves become cocked (misaligned) or otherwise do not snap together easily, pull them apart and start over.
8. After the two breakaway halves are properly snapped together, give the reassembled breakaway a strong pull to verify that it is properly connected.
9. Perform Section 1.4 – Procedure for Operator Reconnection of Breakaway and Testing Fueling Point after a Drive-Off in the Assist Systems Scheduled Maintenance.

MAINTENANCE

Inspect breakaways regularly for damage, loose connections or leaks. Replace as necessary. Subject to customer abuse, breakaways should be replaced when damaged.

The breakaway is designed and constructed to give lasting service if properly handled and maintained. If for any reason it should need attention, contact your VST distributor for proper disposition.

NOTE:

Due to abuse, misuse, changing gasoline formulas, variation in maintenance practices, environmental conditions and/or conditions beyond the manufacture’s control, dispensing equipment may need replacement before five (5) years. Inspections and proper maintenance procedures should be followed by the station manager to determine if replacement is required before five (5) years.

WARNING

Unauthorized rebuilding or modifying of breakaways voids ALL approvals and warranties.

VST products must be used in compliance with applicable federal, state and local laws and regulations.